

LV-6714

Mini-ITX Desktop Motherboard

User's Manual

Edition 1.3

2023/04/26

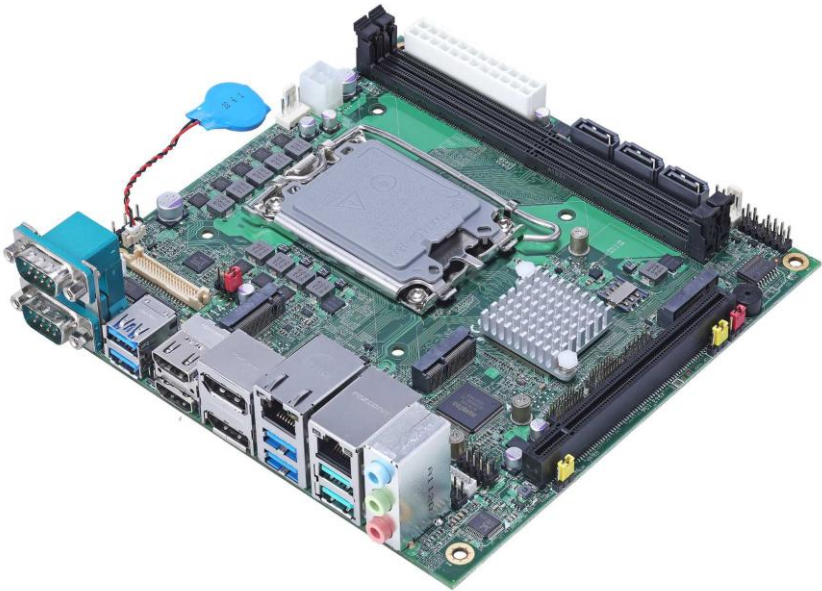

Copyright

Copyright 2023, all rights reserved. This document is copyrighted and all rights are reserved. The information in this document is subject to change without prior notice to make improvements to the products.

This document contains proprietary information and protected by copyright. No part of this document may be reproduced, copied, or translated in any form or any means without prior written permission of the manufacturer.

All trademarks and/or registered trademarks contains in this document are property of their respective owners.

Disclaimer

The company shall not be liable for any incidental or consequential damages resulting from the performance or use of this product.

The company does not issue a warranty of any kind, express or implied, including without limitation implied warranties of merchantability or fitness for a particular purpose.

The company has the right to revise the manual or include changes in the specifications of the product described within it at any time without notice and without obligation to notify any person of such revision or changes.

Trademark

All trademarks are the property of their respective holders.

Any questions please visit our website at <http://www.commell.com.tw>

Packing List:

Please check the package content before you starting using the board.

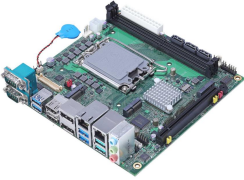

1 x LV-6714 Mini-ITX Motherboard

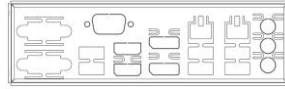

1 x I/O Shield
(OPLATE-CUHDLAT) / (1270077)



2 x SATA Cable
(OALSATA3-L) / (1040529)



1 x Driver CD
(Including User's Manual)

OPTIONAL:

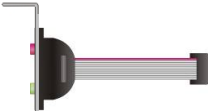

1 x Audio cable
(OALPJ-HD) / (1040120)



1 x USB2.0 Cable
(OALUSBA-1) / (1040172)



1 x Dual COM PORT Cable
(OALES-BKU2) / (1040087)

Index

Chapter 1 <Introduction>	4
1.1 <Product Overview>.....	4
1.2 <Product Specification>	5
1.3 <Block Diagram>.....	6
Chapter 2 <Hardware setup>	7
2.1 <Connector Location and Reference>	7
2.1.1 <Internal connectors list>	8
2.1.2 <External connectors list>.....	8
2.2 <CPU and Memory Setup>	9
2.2.1 <CPU installation>	9
2.2.2 <Memory Setup>	9
2.3 <Jumper Location and Reference>	10
2.3.1 <Jumper list>	10
2.3.2 <Clear CMOS and Power on type selection>.....	11
2.4 <I/O interface>	11
2.4.1 <Serial ATA interface>	11
2.4.2 <Ethernet interface>.....	12
2.4.3 <Display interface>	12
2.4.4 <Serial Port interface>	15
2.4.5 <USB interface>.....	17
2.4.6 <Audio interface>.....	18
2.4.7 <Expansion slot>.....	19
2.4.8 <Front panel switch and indicator>	20
2.4.9 <GPIO and Other interface>	21
2.5 <Power supply>	23
2.5.1 <Power input>	23
Appendix A <Flash BIOS>	25
Appendix B <LCD Panel Type select>	26
Appendix C <Programmable Watch Dog Timer>	27
Appendix D <Hardware Monitor>	29
Appendix E <Programmable GPIO>	30
Appendix F <RAID Setting>	31
Contact information	32

Chapter 1 <Introduction>

1.1 <Product Overview>

LV-6714 is a Mini-ITX Motherboard which supports 12th & 13th Gen Desktop Processors, integrated DDR5 memory, Realtek High Definition Audio, Intel Gigabit LAN, USB3.2 Gen2, SATA3 with AHCI function for a system.

New feature for Alder Lake(12th) & Raptor Lake(13th)

12th & 13th Gen Desktop Processors are based on the Intel 7 SuperFin process, and offer long-life availability. i9-12900 with 8 P-cores and 8 E-cores. P-cores can help you handle heavy tasks, and E-cores run background tasks efficiently to save power. Support DDR5 Memory up to 4800 and PCIe gen 5 x16 Slot.

All in One multimedia solution

The board provides one M.2 3042 slot (support SATA), one M.2 2230 slot, one M.2 2280 slot (PCIe Gen4), and one PCIe x16 slot (PCIe Gen5 X16).

Alder Lake support Windows10 version 21H2 64bit and Linux 5.18

Intel recommends using Windows 10 version 21H2 64bit. It may lose some drivers if you use other Windows version.

1.2 <Product Specification>

System

Processor	Support 12 th & 13 th Gen Intel® Core™ Desktop Processors FCLGA1700 package (Support up to 65W TDP CPU)
Chipset	Intel® Q670E
Memory	2 x DDR5 DIMM 4800 MHz up to 64GB, Support Non-ECC, unbuffered memory only
Watchdog Timer	Generates a system reset with internal timer for 1min/s ~ 255min/s
Real Time Clock	Chipset integrated RTC with onboard lithium battery
Expansion	1 x M.2 2230 Key E for Wi-Fi and Bluetooth 1 x M.2 2280 Key M support PCIe Gen4 or SATA 1 x M.2 3042 Key B for 4G / 5G module or SATA with SIM slot 1 x PCIe X16 slot support PCIe Gen5

Graphics

Chipset	Intel® UHD Graphics 770 / 730 / 710
Display Interface	1 x LVDS (Note1), 2 x HDMI, 2 x DisplayPort (Note2)

LAN

Chip	1 x Intel® I219-LM Gigabit LAN PHY (Support iAMT16.0) 1 x Intel® I226-LM Gigabit LAN
-------------	---

I/O

Serial ATA	3 x SATA3
Audio	Realtek ALC888S HD Audio
Internal I/O	3 x SATA3, 4 x RS232, 2 x USB2.0, 1 x LVDS, 1 x SIM slot 1 x LCD inverter connector , 1 x GPIO , 1 x Audio, 1 x SMBus
Rear I/O	2 x HDMI, 2 x DisplayPort, 1 x Audio, 2 x LAN, 6 x USB3.2 Gen2 2 x RS232/RS422/RS485

Mechanical & Environmental

Power Requirement	Standard 24-pin ATX power supply and 4-pin 12V
Size & Thickness	170mm x 170mm (L x W)
Temperature	Operating within 0°C~60°C (32°F~140°F) Storage within -20°C~80°C (-4°F~176°F)
Relative Humidity	10%~90%, non-condensing

Note1: Onboard 18/24-bit single/dual channel +3.3V/ +5V/ +12V LVDS

Note2: Add ADP-3355 supports VGA or Add ADP-3460 supports 2nd LVDS, please contact with our sales for OEM version.

1.3 <Block Diagram>

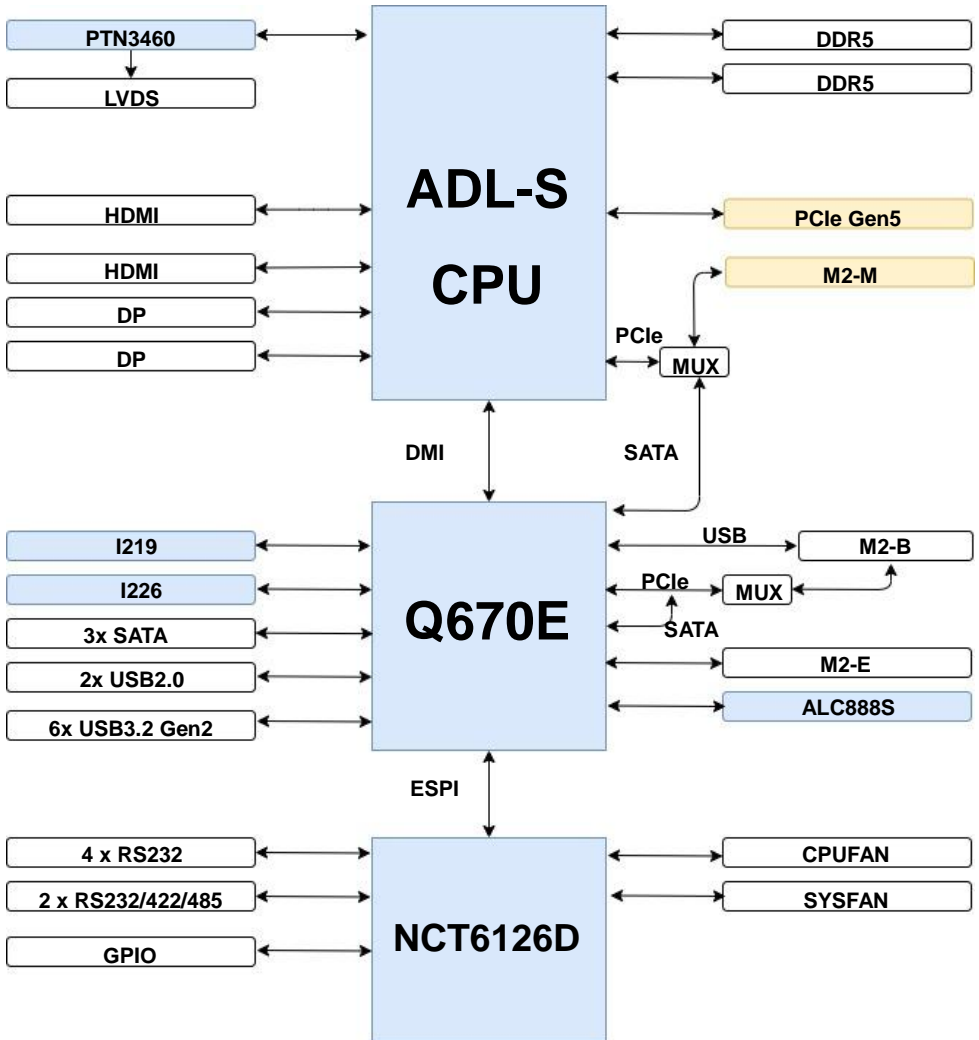

Chapter 2 <Hardware setup>

2.1 <Connector Location and Reference>

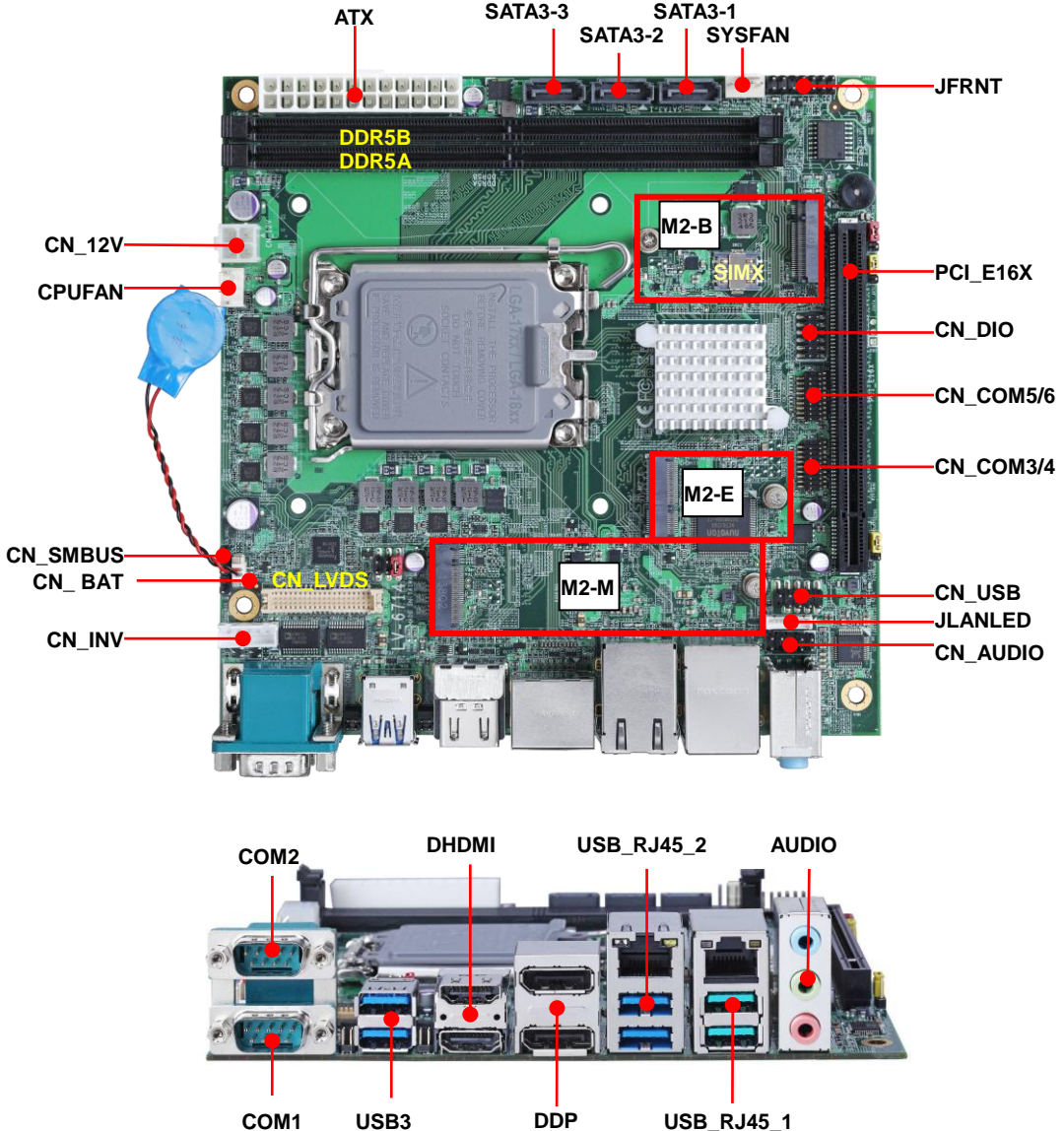

2.1.1 <Internal connectors list>

Connector	Function
DDR5_A/B	288-pin DDR5 DIMM slot
SATA3-1/2/3	7-pin SATA3 connector
CN_AUDIO	5 x 2-pin audio pin header
CN_LVDS	20 x 2-pin LVDS connector
CN_INV	5-pin LCD inverter connector
CN_SMBUS	5-pin SMBus connector
CN_COM 3/4/5/6	20-pin RS232 connector
CN_USB	5 x 2-pin USB2.0 pin header
CN_DIO	6 x 2-pin digital I/O connector
CPUFAN	4-pin CPU fan connector
SYSFAN	4-pin system fan connector
JFRNT	14-pin front panel switch/indicator connector
JLANLED	8-pin RJ45 LED Connector
PCI_E16X	164-pin x16 PCIE slot (Supoport PCIe Gen5)
M2_E	75-pin M.2 Key E slot
M2_M	75-pin M.2 Key M slot (Supoport PCIe Gen4 or SATA)
M2_B	75-pin M.2 Key B slot (Supoport 4G / 5G module or SATA)
ATX	24-pin power supply connector
CN_12V	4-pin power input Terminal Block
SIMM	6-pin socket

2.1.2 <External connectors list>

Connector	Function
DDP	Dual DisplayPort connector
DHDMI	Dual HDMI connector
USB3	Dual USB3.2 Gen2 connector
USB_RJ45_1/2	RJ45 and Dual USB3.2 Gen2 connector
AUDIO	Audio connector
COM1/2	DB9 Serial port connector

2.2 <CPU and Memory Setup>

2.2.1 <CPU installation>

LV-6714 has a LGA1700 CPU socket onboard; please check following steps to install the processor properly.

Attention If LV-6714 needs RMA please Keep CPU socket cover on the CPU Socket.
Warning If CPU Socket internal Pin damage We could not provide warranty.

[LGA 1700 Install manual from Intel](#)

[LGA 1700 Install video from Intel](#)

2.2.2 <Memory Setup>

LV-6714 has two 288-pin DDR5 DIMM support up to 64GB of memory capacity and 1.1 Voltage. The memory frequency supports 4800 MHz.



Please check the pin number to match the socket side well before installing memory module.

2.3 <Jumper Location and Reference>

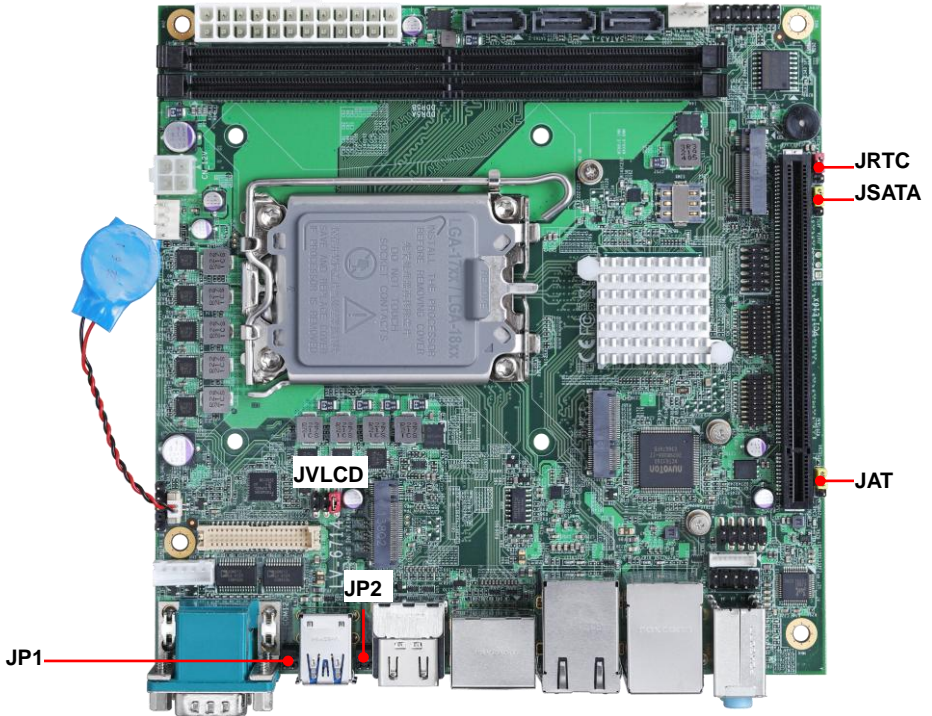

2.3.1 <Jumper list>

Jumper	Function
JAT	Power mode select
JRTC	CMOS Normal/Clear Setting
JVLCD	Panel Voltage Setting
JSATA	M2-B PCIe /SATA Setting
JP1	COM1 Voltage Setting (For Pin 9)
JP2	COM2 Voltage Setting (For Pin 9)

2.3.2 <Clear CMOS and Power on type selection>

The board's data of CMOS can be setting in BIOS. If the board refuses to boot due to inappropriate CMOS settings, here is how to proceed to clear (reset) the CMOS to its default values.

JRTC: Clear CMOS data jumper

Jumper settings	Function
1-2	Clear CMOS
2-3	Normal (Default)

JAT: AT/ATX mode select jumper

Jumper settings	Function
1-2	AT mode
2-3	ATX mode (Default)

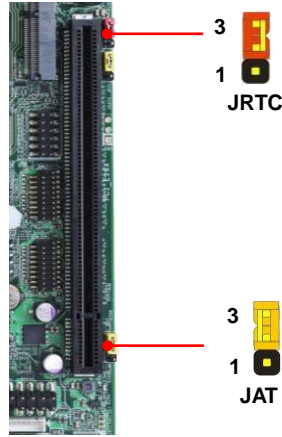

2.4 <I/O interface>

2.4.1 <Serial ATA interface>

SATA 1/2/3: SATA3 7-pin connector

Pin	Signal
1	GND
2	TX+
3	TX-
4	GND
5	RX-
6	RX+
7	GND

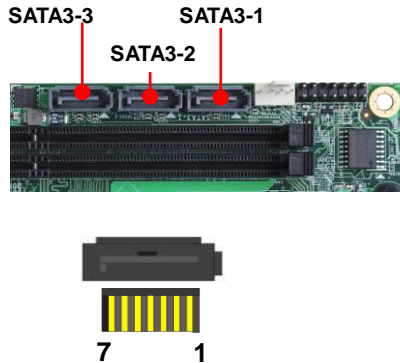

2.4.2 <Ethernet interface>

The board provide I219-LM PHY Gigabit Ethernet and I226 2.5 Gigabit Ethernet on rear I/O. Intel I226 supports operation at 100/1000/2500 Mb/s data rates, with IEEE802.3 compliance and Wake-On-LAN supported.

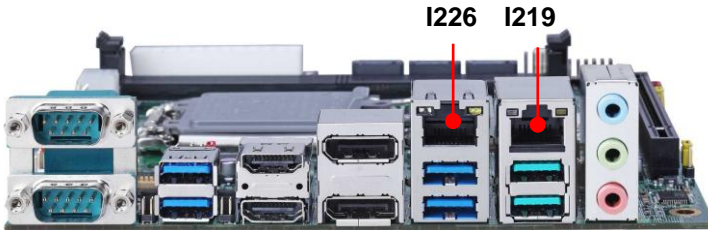

2.4.3 <Display interface>

Based on the 12th Gen CPU with built-in UHD Graphics 730, DisplayPort up to **4096x2304@60Hz**, HDMI up to **4096x2304@24Hz** on rear IO. About the internal Display, LVDS (PTN3460) up to **1920x1200@60Hz** support 18/24-bit color depth and single/dual channel. About select LCD Panel Type in BIOS, please refer [Appendix B](#).

The built-in HD Graphics support triple display function with clone mode and extended mode.

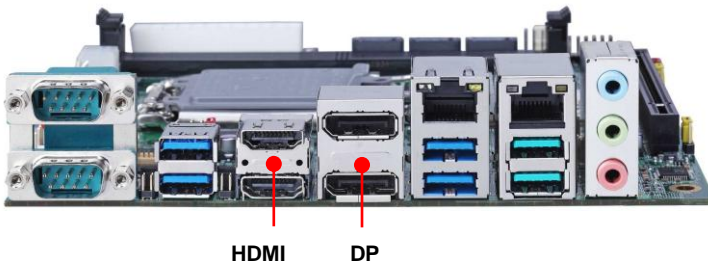

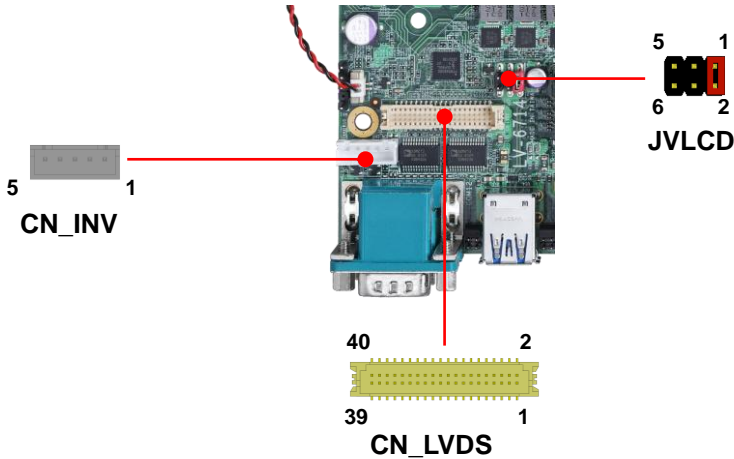

CN_LVDS: LVDS 40-pin connector (Model: HIROSE DF13-40DP-1.25V compatible)

Pin	Signal	Pin	Signal
2	Set by JVLCD	1	Set by JVLCD
4	Detect (Active low)	3	GND
6	A_LVDS_0-	5	B_LVDS_0-
8	A_LVDS_0+	7	B_LVDS_0+
10	GND	9	GND
12	A_LVDS_1-	11	B_LVDS_1-
14	A_LVDS_1+	13	B_LVDS_1+
16	GND	15	GND
18	A_LVDS_2-	17	B_LVDS_2-
20	A_LVDS_2+	19	B_LVDS_2+
22	GND	21	GND
24	A_LVDS_CLK-	23	B_LVDS_3-
26	A_LVDS_CLK+	25	B_LVDS_3+
28	GND	27	GND
30	A_LVDS_3-	29	B_LVDS_CLK-
32	A_LVDS_3+	31	B_LVDS_CLK+
34	GND	33	GND
36	LVDS_DDCSCL	35	NC
38	LVDS_DDCSDA	37	NC
40	NC	39	NC

Pin4 only need to be connected to GND

CN_INV: LVDS 5-pin Backlight power connector

Pin	Signal
1	12V
2	Backlight Control
3	GND
4	GND
5	Enable Backlight

JVLCD: LVDS panel power select jumper

Jumper settings	Function
1-2	3.3V (Default)
3-4	5V
5-6	12V

2.4.4 <Serial Port interface>

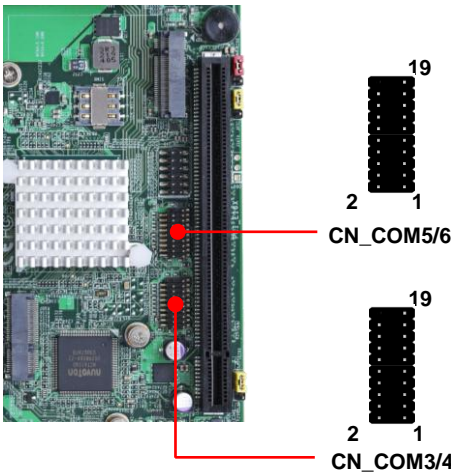
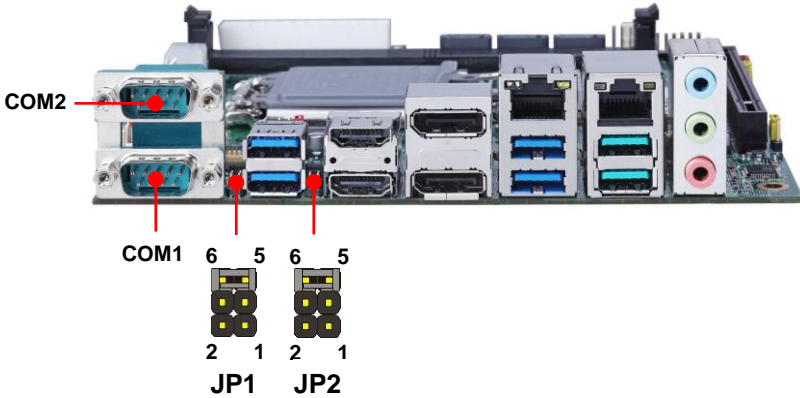

COM1: RS232/422/485 DB9 connector

Pin	Signal	Pin	Signal
1	DCD/ 422TX-/ 485-	2	RXD/ 422TX+/ 485+
3	TXD	4	DTR
5	GND	6	DSR/ 422RX+
7	RTS	8	CTS/ 422RX-
9	Set by JP1		

COM2: RS232/422/485 DB9 connector

Pin	Signal	Pin	Signal
1	DCD/ 422TX-/ 485-	2	RXD/ 422TX+/ 485+
3	TXD	4	DTR
5	GND	6	DSR/ 422RX+
7	RTS	8	CTS/ 422RX-
9	Set by JP2		

COM1 & COM2

RS-232/422/485 can set by BIOS.

You can find the setting from

Advanced-> Motherboard Advanced menu-> Super IO configuration-> Serial Port configuration->Interface

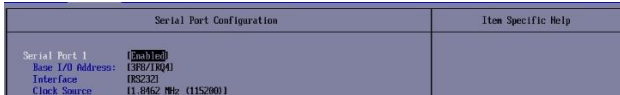

If you want to use RS485, please follow below step before connection. .

COM1 RTX- Data- : short Pin1& Pin8
 COM1 RTX+ Data+ : short Pin2& Pin6
 COM2 RTX- Data-: short Pin1& Pin8
 COM2 RTX+ Data+: short Pin2& Pin6

JP1, JP2: COM1, COM2 pin-9 setting

Jumper settings	Function
1-2	5V
3-4	12V
5-6	RI (Default)

Effective patterns of connection:

1-2 / 3-4 / 5-6

Other may cause damage

COM3/4,COM5/6: COM 20-pin header (Pitch 2.54 x 1.27mm)

Pin	Signal	Pin	Signal
1	DCD1	2	RXD1
3	TXD1	4	DTR1
5	GND	6	DSR1
7	RTS1	8	CTS1
9	RI1	10	NC
11	DCD2	12	RXD2
13	TXD2	14	DTR2
15	GND	16	DSR2
17	RTS2	18	CTS2
19	RI2	20	Key

2.4.5 <USB interface>

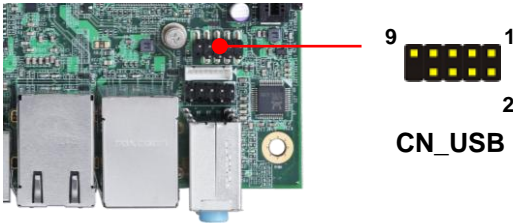
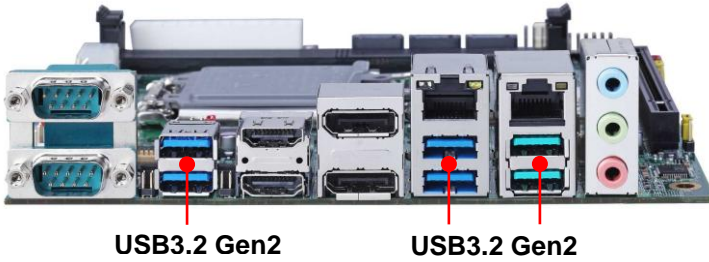

CN_USB : USB2.0 10-pin header (Pitch 2.54 mm)

Pin	Signal	Pin	Signal
1	5VSB	2	5VSB
3	DATA0-	4	DATA1-
5	DATA0+	6	DATA1+
7	GND	8	GND
9	GND	10	Key

2.4.6 <Audio interface>

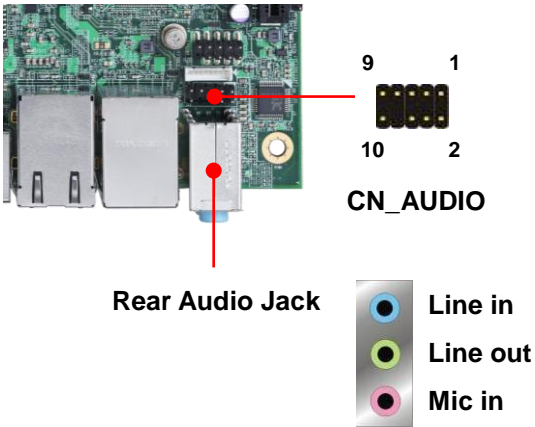

CN_AUDIO: Front panel audio 10-pin header (Pitch 2.54mm)

Pin	Signal	Pin	Signal
1	MIC_L	2	GND
3	MIC_R	4	NC
5	FP_OUT_R	6	MIC_DETECT
7	SENSE	8	Key
9	FP_OUT_L	10	FP_OUT_DETECT

2.4.7 <Expansion slot>

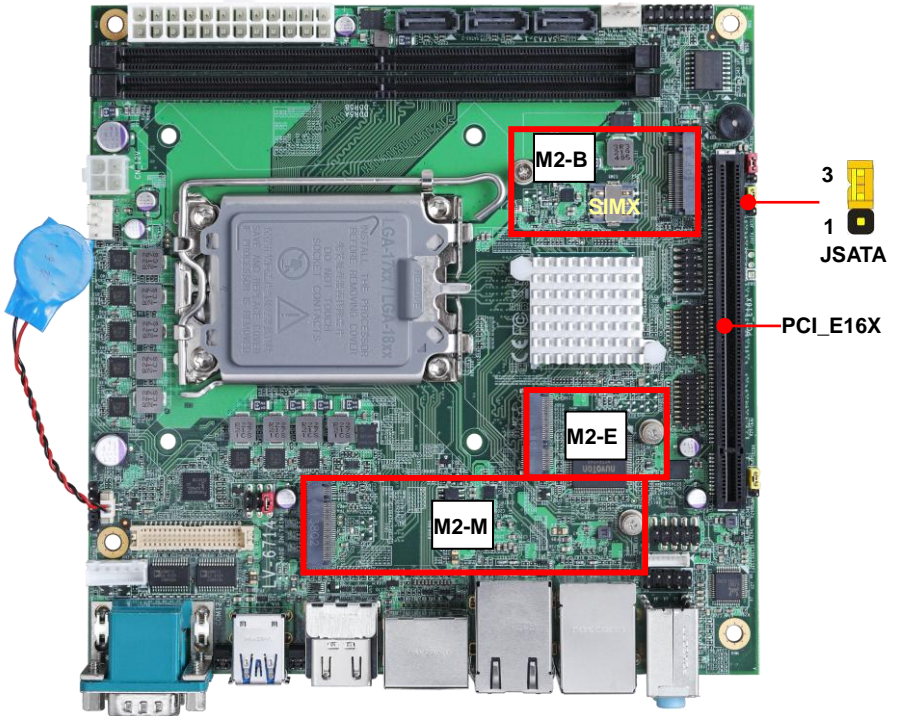

M2-B can support SATA by JSATA or 4G / 5G module, and connect SIM slot

M2-E can support WI-FI and Bluetooth Module

M2-M with 4 x PCIe Gen4 supports NVMe SSD or SATA

PCI_E16X can support PCIe Gen 5 x16

JSATA: Setting M2-B supports PCIe/SATA

Jumper settings	Function
1-2	Support PCIe
2-3	Support M.2 KEY B 2242 SATA (Default)

2.4.8 <Front panel switch and indicator>

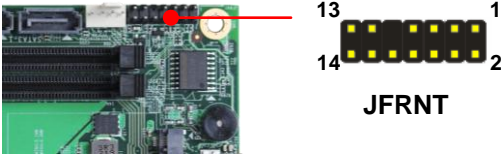

JFRNT: Front panel switch and indicator 14-pin header (Pitch 2.54mm)

Pin	Signal	Pin	Signal
1	HDD_LED+	2	Power_LED+
3	HDD_LED-	4	NC
5	Reset+	6	Power_LED-
7	Reset-	8	Speaker+
9	Key	10	NC
11	Power_ON+	12	NC
13	Power_ON-	14	Speaker-

2.4.9 <GPIO and Other interface>

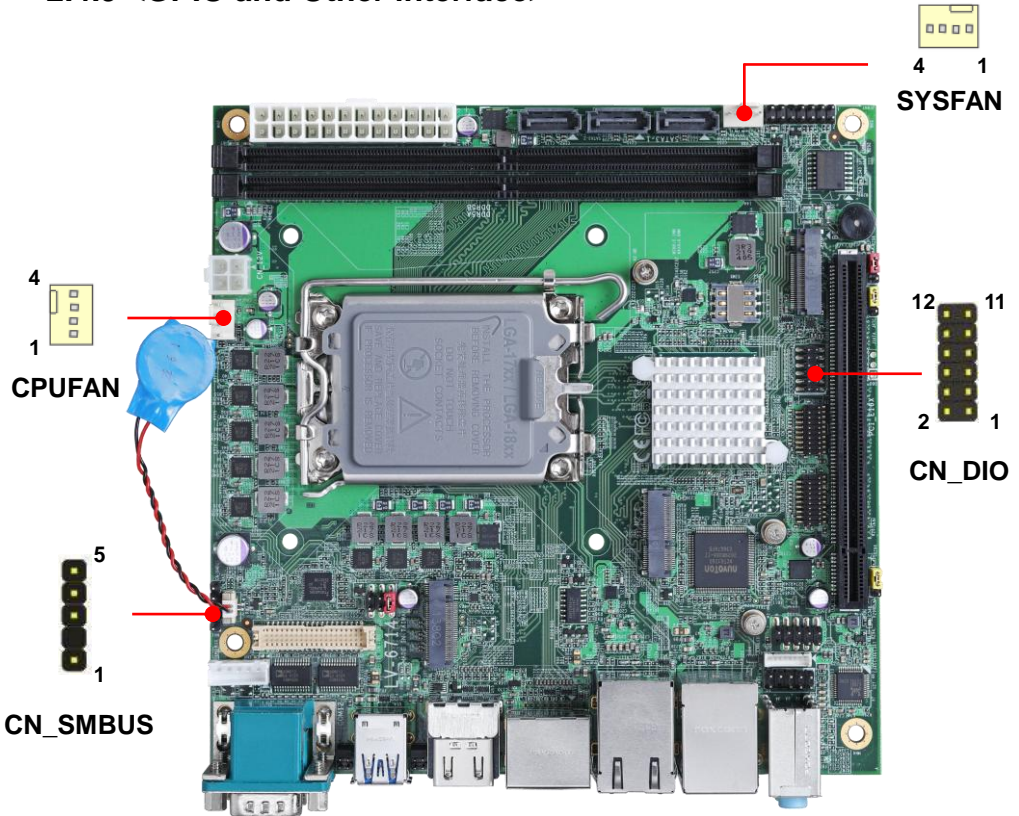

When using GPIO function, please note:

As Output: **Open-drain**, most applications need use an external pull up resistor.
(If not may cause damage)

As Input: **TTL-level**.

GPIO DC characteristics (open drain mode)

Parameter	SYM	MIN	TYP	MAX	UNIT	Conditions
Input Low Voltage	V_{IL}			0.8	V	
Input High Voltage	V_{IH}	2.0			V	
Output Low Voltage	V_{OL}			0.4	V	$I_{OL}=12mA$
Input High Leakage	I_{LH}			+10	μA	$V_{IN}=3.3V$
Input Low Leakage	I_{LH}			-10	μA	$V_{IN}=0V$

Please refer to [Appendix E](#) to program the configuration register

CN_DIO: GPIO 12-pin header (Pitch 2.00mm)

Pin	Signal	Pin	Signal
1	GND	2	GND
3	GP40	4	GP44
5	GP41	6	GP45
7	GP42	8	GP46
9	GP43	10	GP47
11	5V	12	12V

CN_SMBUS: SMBus 5-pin connector (Pitch 2.54mm)

Pin	1	2	3	4	5
Signal	5V	NC	SMBDAT	SMBCLK	GND

CPUFAN: CPU cooler fan 4-pin connector

Pin	1	2	3	4
Signal	GND	12V	Sensor	Control

SYSFAN: System cooler fan 4-pin connector

Pin	1	2	3	4
Signal	GND	12V	Sensor	Control

2.5 <Power supply>

2.5.1 <Power input>

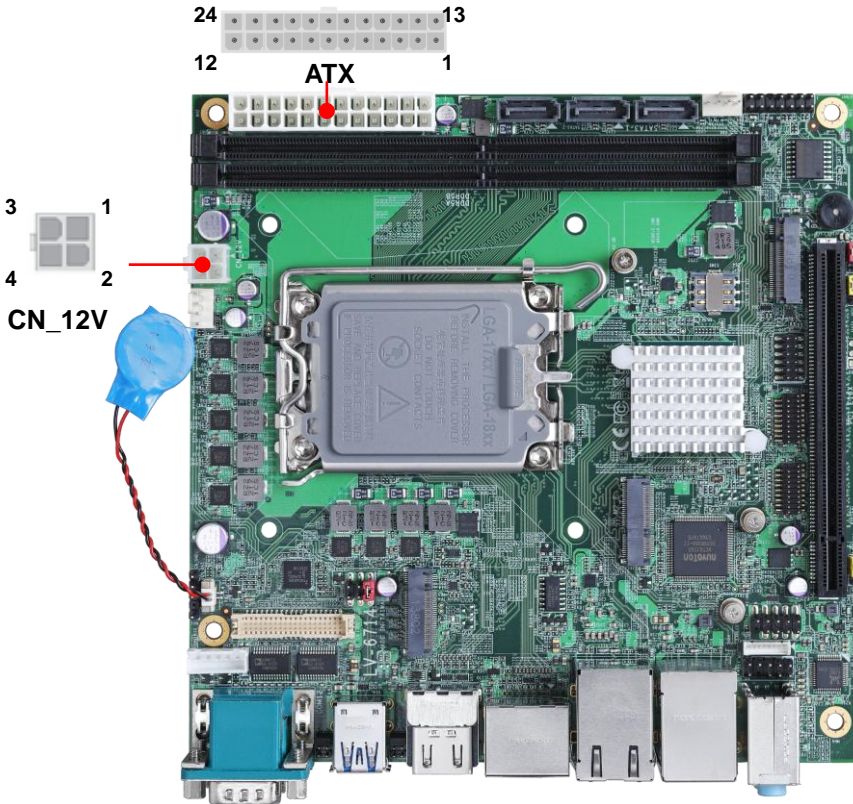

CN_12V: ATX12V 4-pin connector

Pin	Signal	Pin	Signal
1	GND	2	GND
3	12V	4	12V

ATX: main power 24-pin connector (As input)

Pin	Signal	Pin	Signal
1	3.3V	13	3.3V
2	3.3V	14	NC
3	GND	15	GND
4	5V	16	-PSON
5	GND	17	GND
6	5V	18	GND
7	GND	19	GND
8	Power_OK	20	NC
9	5VSB	21	5V
10	12V	22	5V
11	12V	23	5V
12	3.3V	24	GND

Appendix A <Flash BIOS>

A.1 <Flash tool>

The board is based on Phoenix BIOS and can be updated easily by the BIOS auto flash tool. You can download the tool online at the address below:

[FPT Tool](#)

The tool's file name is "FPT.exe", it's the utility that can write the data into the BIOS flash chip and update the BIOS.

A.2 <Flash BIOS process>

- 1.Extract the zip file(re-flash tool and BIOS file) to root of the USB flash drive.
- 2.Insert your USB flash drive in USB port of the board and power on the system.
- 3.Press F5 in the Phoenix Logo screen
- 4.Click the Internal Shell, then input the "fs0:" command to switch to the root of the USB flash drive.
5. Type the " fpt -savemac -f xxx.bin" command to start flash BIOS processes. (xxx.bin means the BIOS file that you want to update)
6. When it finished all update processes, restart the system.

```

UEFI Interactive Shell v2.2
EDK II
UEFI v2.70 (Phoenix Technologies Ltd., 0x12345678)
Mapping table
FS0: Alias(s) :HD0p0b::BLK1:
    PciRoot(0x0)/Pci(0x14,0x0)/USB(0xF,0x0)/HD(1,GPT,C08627CA-4DD0-443C-B57C-965C9707287B,0x800,0x3947303)
FS1: Alias(s) :HD1b::BLK3:
    PciRoot(0x0)/Pci(0xE,0x0)/NvMe(0x1,03-12-04-00-00-3E-69-24)/HD(1,GPT,FC7D92D0-5901-4BB4-B062-417B361790AC,0x800,0x3200)
0)
BLK0: Alias(s) :
    PciRoot(0x0)/Pci(0x14,0x0)/USB(0xF,0x0)
BLK2: Alias(s) :
    PciRoot(0x0)/Pci(0xE,0x0)/NvMe(0x1,03-12-04-00-00-3E-69-24)
BLK7: Alias(s) :
    PciRoot(0x0)/Pci(0xE,0x0)/NvMe(0x2,04-12-04-00-00-3E-69-24)
BLK4: Alias(s) :
    PciRoot(0x0)/Pci(0xE,0x0)/NvMe(0x1,03-12-04-00-00-3E-69-24)/HD(2,GPT,03602963-A321-4529-A295-076CF6740D24,0x32000,0x00)
00)
BLK5: Alias(s) :
    PciRoot(0x0)/Pci(0xE,0x0)/NvMe(0x1,03-12-04-00-00-3E-69-24)/HD(3,GPT,7043D5DE-C0A7-45EA-825F-8CDD2FDC016D,0x30800,0x1BDE028D)
BLK6: Alias(s) :
    PciRoot(0x0)/Pci(0xE,0x0)/NvMe(0x1,03-12-04-00-00-3E-69-24)/HD(4,GPT,E12B4413-6F05-4A2B-A7B3-D46626709E00,0x1BE25000,0xFE00)
Press ESC in 1 seconds to skip startup.nsh or any other key to continue.
Shell>
Shell> fs0:
FS0:\> fpt -savemac -f 6715_bin_
    
```

Appendix B <LCD Panel Type select>

According your panel, it needs to select the correct resolution in the BIOS. If there is no fit your panel type, please feedback for us to make OEM model.

Find the setting from

Advanced->Motherboard Advanced menu->LVDS Configuration

EDID Panel type: There are 7 resolutions in LCD Panel Type, if your panel is not in the list, please contact tech@commell.com.tw

LVDS Bus: Select Single / Dual channel

Panel Color Depth: Select VESA 24 bit / JEIDA 24 bit / VESA and JEIDA 18 bit

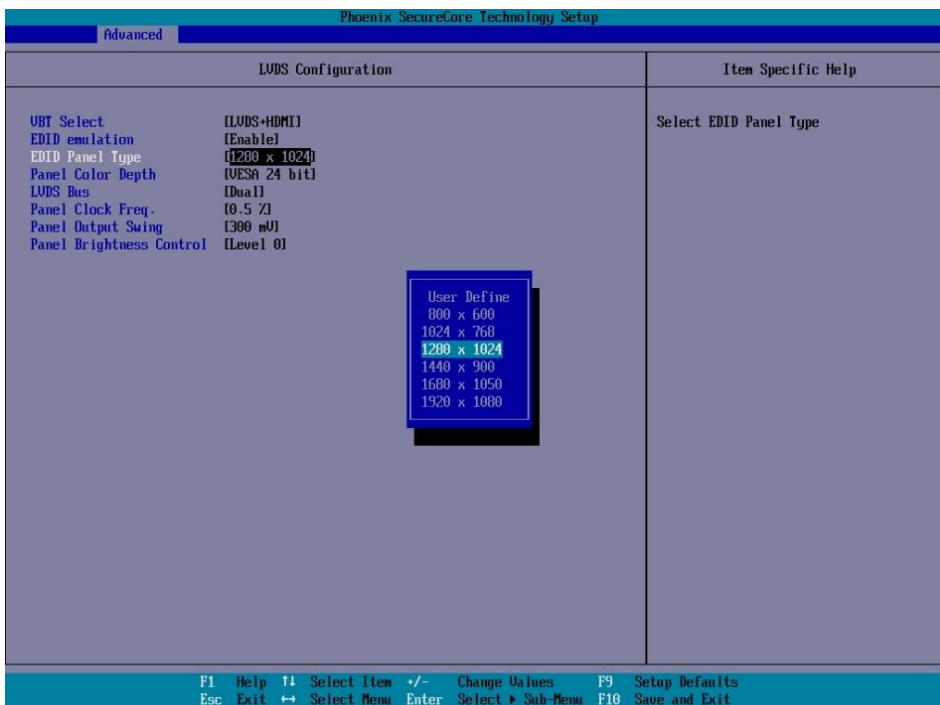

Appendix C <Programmable Watch Dog Timer>

The watchdog timer makes the system auto-reset while it stops to work for a period. The integrated watchdog timer can be setup as system reset mode by program. You can select Timer setting in the BIOS, after setting the time options, the system will reset according to the period of your selection.

Find the setting from

Advanced→Motherboard Advanced Menu→Power Advanced menu→

Watch dog timer select



Program sample

Watchdog timer setup as system reset with 5 second of timeout

```
-o 4E 87      ;enter configuration
-o 4E 87
-o 4E 07
-o 4F 08      ;select Logical Device
-o 4E 30
-o 4F 01      ; activate WDTO# function
-o 4E F0
-o 4F 00      ;set "00" is second mode, set "08" is minute mode
-o 4E F1
-o 4F 05      ;00h: Timeout Disable
                ;01h: Timeout occurs after 1 minute only
                ;02h: Timeout occurs after 2 second/minute
                ;03h: Timeout occurs after 3 second/minute
                ;
                ;FFh: Timeout occurs after 255 second/minute
                (The deviation is approx 1 second.)
```

For further information, please refer to Nuvoton NCT6126D datasheet

Appendix D <Hardware Monitor>

Find the setting from

Advanced-> Motherboard Advanced menu-> Super IO configuration->

→Hardware Monitor

Advanced	
Hardware Monitor	
System Temperature	[31 C]
PECI Temperature	[31 C]
System Fan Speed	[0 RPM]
CPU Fan Speed	[4530 RPM]
Battery 3V (VBAT)	[2.976 V]
CPU VCCORE	[1.312 V]
12V	[12.030 V]
5V	[5.040 V]
3.3V	[3.312 V]

Appendix E <Programmable GPIO>

The GPIO can be programmed with the MS-DOS debug program using simple IN/OUT commands.

GPIO	0	1	2	3	4	5	6	7
bit	0	1	2	3	4	5	6	7

- o 4E 87 ;enter configuration
- o 4E 87
- o 4E 07
- o 4F 07 ;select Logical Device
- o 4E 30
- o 4F 10 ;activate GPIO function (The board use GPIO4)
- o 4E F0
- o 4F XX ;set "01" GPIO as input, set "00" GPIO as output
- o 4E F1
- o 4F XX ;if set GPIO as output, this register's value can be set "00~ FF"

Optional

- o 4E F2
- o 4F XX ;set "01", the respective bit are inverted (Both input and output)
- ;set "00", the respective bit are normal

For further information, please refer to Nuvoton NCT6126D datasheet

Appendix F <RAID Setting>

When use RAID function, it need to enter the BIOS set RAID mode first.

Advanced → Intel Advanced menu → SA Configuration → VMD Configuraion →

1. Find VMD controller, and set to enable
2. Set “Map this Root port under VMD” to enable.
3. Set “Intel Optane memory to disabled
4. Press F10 to save.
5. In Misc page, you can find Intel® Rapid Storage Technology,
6. You can see “Create RAID Volume”, then choose two disks to create.

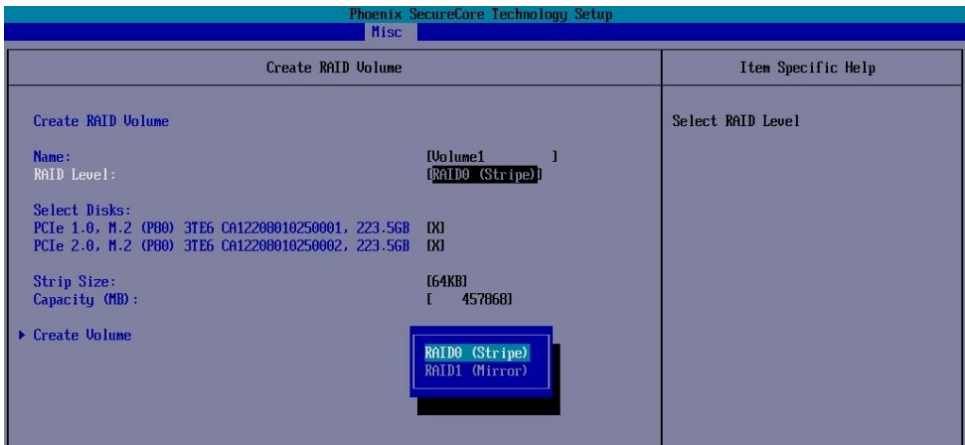

Contact information

Any advice or comment about our products and service, or anything we can help you please don't hesitate to contact with us. We will do our best to support you for your products, projects and business.

Taiwan Commate computer Inc.

Address	19F., NO.94, Sec. 1, Xintai 5 th Rd., Xizhi Dist., New Taipei City 22102, Taiwan.
TEL	+886-2-26963909
Website	www.commell.com.tw
E-mail	info@commell.com.tw (General information) tech@commell.com.tw (Technical Support)

Commell is a brand name of Taiwan Commate computer Inc.