

LV-67X

Mini-ITX Desktop Motherboard

User's Manual

Edition 1.8
2022/11/15

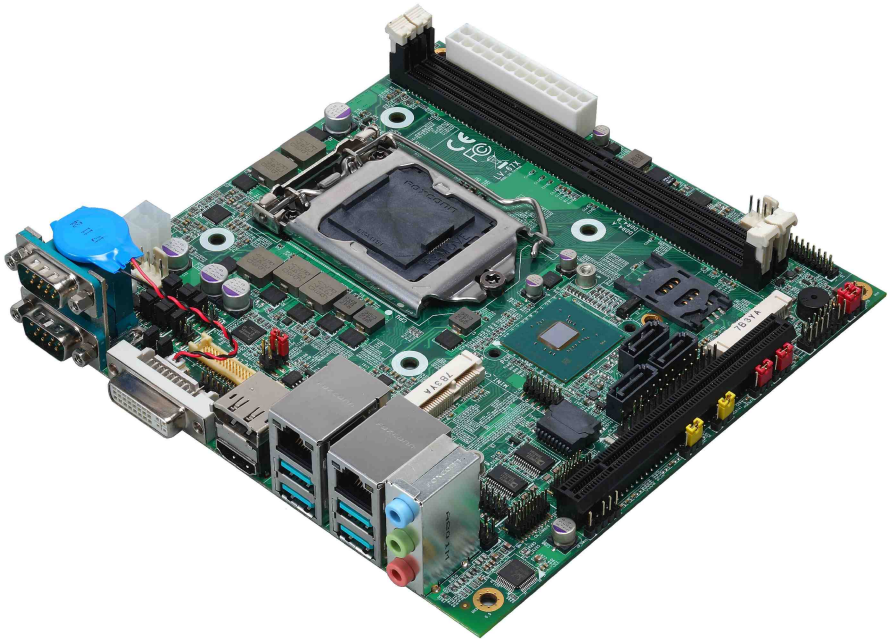

Copyright

Copyright 2021, all rights reserved. This document is copyrighted and all rights are reserved. The information in this document is subject to change without prior notice to make improvements to the products.

This document contains proprietary information and protected by copyright. No part of this document may be reproduced, copied, or translated in any form or any means without prior written permission of the manufacturer.

All trademarks and/or registered trademarks contains in this document are property of their respective owners.

Disclaimer

The company shall not be liable for any incidental or consequential damages resulting from the performance or use of this product.

The company does not issue a warranty of any kind, express or implied, including without limitation implied warranties of merchantability or fitness for a particular purpose.

The company has the right to revise the manual or include changes in the specifications of the product described within it at any time without notice and without obligation to notify any person of such revision or changes.

Trademark

All trademarks are the property of their respective holders.

Any questions please visit our website at <http://www.commell.com.tw>

Packing List:

Please check the package content before you starting using the board.



1 x LV-67X Mini-ITX Motherboard



1 x VGA Cable
(OALVGA-SNB-7) / (1040557)

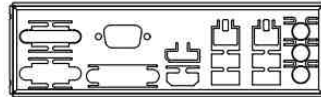

1 x I/O Shield
(OPLATE-CDILAT) / (1270067)



2 x SATA Cable
(OALSATA3-L) / (1040529)



1 x Driver CD
(Including User's Manual)

OPTIONAL:

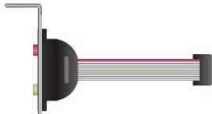

1 x Audio cable
(OALPJ-HD) / (1040120)

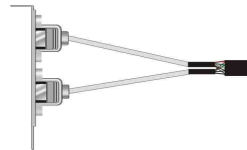

1 x USB2.0 Cable
(OALUSBA-1) / (1040172)

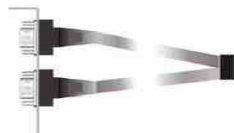

1 x Dual COM PORT Cable
(OALES-BKU2) / (1040087)

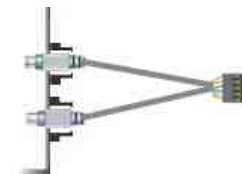

1 x PS/2 Keyboard & Mouse cable
(OALPS2/KMB) / (1040610)

Index

Chapter 1 <Introduction>	4
1.1 <Product Overview>.....	4
1.2 <Product Specification>	5
1.3 <Block Diagram>.....	6
Chapter 2 <Hardware setup>	7
2.1 <Connector Location and Reference>	7
2.1.1 <Internal connectors list>	8
2.1.2 <External connectors list>.....	8
2.2 <CPU and Memory Setup>	9
2.2.1 <CPU installation>	9
2.2.2 <Memory Setup>	10
2.3 <Jumper Location and Reference>	11
2.3.1 <Jumper list>	11
2.3.2 <Clear CMOS and Power on type selection>.....	12
2.4 <I/O interface>	12
2.4.1 <Serial ATA interface>	12
2.4.2 <Ethernet interface>.....	13
2.4.3 <Display interface>	13
2.4.4 <Serial Port interface>	16
2.4.5 <USB interface>.....	19
2.4.6 <Audio interface>	21
2.4.7 <Expansion slot>.....	22
2.4.8 <Front panel switch and indicator>	23
2.4.9 <GPIO and Other interface>	24
2.5 <Power supply>	27
2.5.1 <Power input>	27
Appendix A <Flash BIOS>	28
Appendix B <LCD Panel Type select>	29
Appendix C <Programmable Watch Dog Timer>	31
Appendix D <Hardware Monitor>	33
Appendix E <Programmable GPIO>	34
Appendix F <RAID Setting>	35
Appendix G <Setup ADP-3355,ADP-3460>	36
Contact information	36

Chapter 1 <Introduction>

1.1 <Product Overview>

LV-67X is Mini-ITX Motherboard which supports 8th & 9th Gen Intel® Core™, Pentium® and Celeron® processor families with Intel® Q370 Chipset, integrated HD Graphics , DDR4 memory, Realtek High Definition Audio, Intel Gigabit LAN, Serial ATA3

Intel Coffee Lake-S Processor with Intel® Q370 Chipset

8th & 9th Gen Intel® Core™, Pentium® and Celeron® processor families are new generation and multi-core processor built on 14 nanometer process.

It provides new Graphics support 3 independent 4K UHD displays, Memory is support up to 64GB of DDR4, better performance, flexibility and more enhanced security that is suitable for a variety of intelligent systems the ideal choice.

Flexible Expansion Interface

It includes 2 x Minicard slot, PCIe x16 slot, 2 x RS232/RS485/RS422, 6 x USB3.1 Gen2, and 4 x USB2.0.

Coffee Lake only support Windows10 64bit, Linux

Intel only support Windows 10 64bit. It may lose some drivers if you use other Windows version.

1.2 <Product Specification>

System

Processor	Support 8th & 9th Gen Intel® Core™ Desktop Processors, FCLGA1151 package (Support up to 65W TDP)(Note1)
Chipset	Intel® Q370
Memory	2 x DDR4 DIMM 2666 MHz up to 64GB, Support Non-ECC, unbuffered memory only (Core i3, Pentium, Celeron CPU support 2400 MHz only)
Watchdog Timer	Generates a system reset with internal timer for 1min/s ~ 255min/s
Real Time Clock	Chipset integrated RTC with onboard lithium battery
Expansion	1 x MiniPCle (support mSATA) 1 x Half Size MiniPCle 1 x SIM slot 1 x PCIe X16 slot

Graphics

Chipset	Intel® UHD Graphics
Display Interface	1 x DVI, 1 x DisplayPort (optional), 1 x LVDS, 1 x HDMI, 1 x VGA

LAN

Chip	1 x Intel® I219-LM Gigabit PHY LAN (Support iAMT12.0) 1 x Intel® I210-AT Gigabit LAN
------	---

I/O

Serial ATA	3 x SATA3
Audio	Realtek ALC262 HD Audio
Internal I/O	3 x SATA3, 4 x RS232, 4 x USB2.0, 2 x USB3.1 Gen2, 1 x LVDS, 1 x LPC, 1 x LCD inverter, 1 x GPIO, 1 x Audio, 1 x PS/2, 1 x SMBUS, 1 x VGA
Rear I/O	1 x DisplayPort(optional), 1 x DVI, 1 x HDMI, 4 x USB3.1 Gen2, 2 x LAN, 2 x RS232/422/485, 1 x Audio.

Mechanical & Environmental

Power Requirement	Standard 24-pin ATX power supply and 4-pin 12V
Size & Thickness	170mm x 170mm (L x W)
Temperature	Operating within 0°C~60°C (32°F~140°F) Storage within -20°C~80°C (-4°F~176°F)
Relative Humidity	10%~90%, non-condensing

Note1: 8 cores TDP 65W CPU is not supported.(E.g. i7-9700E)

1.3 <Block Diagram>

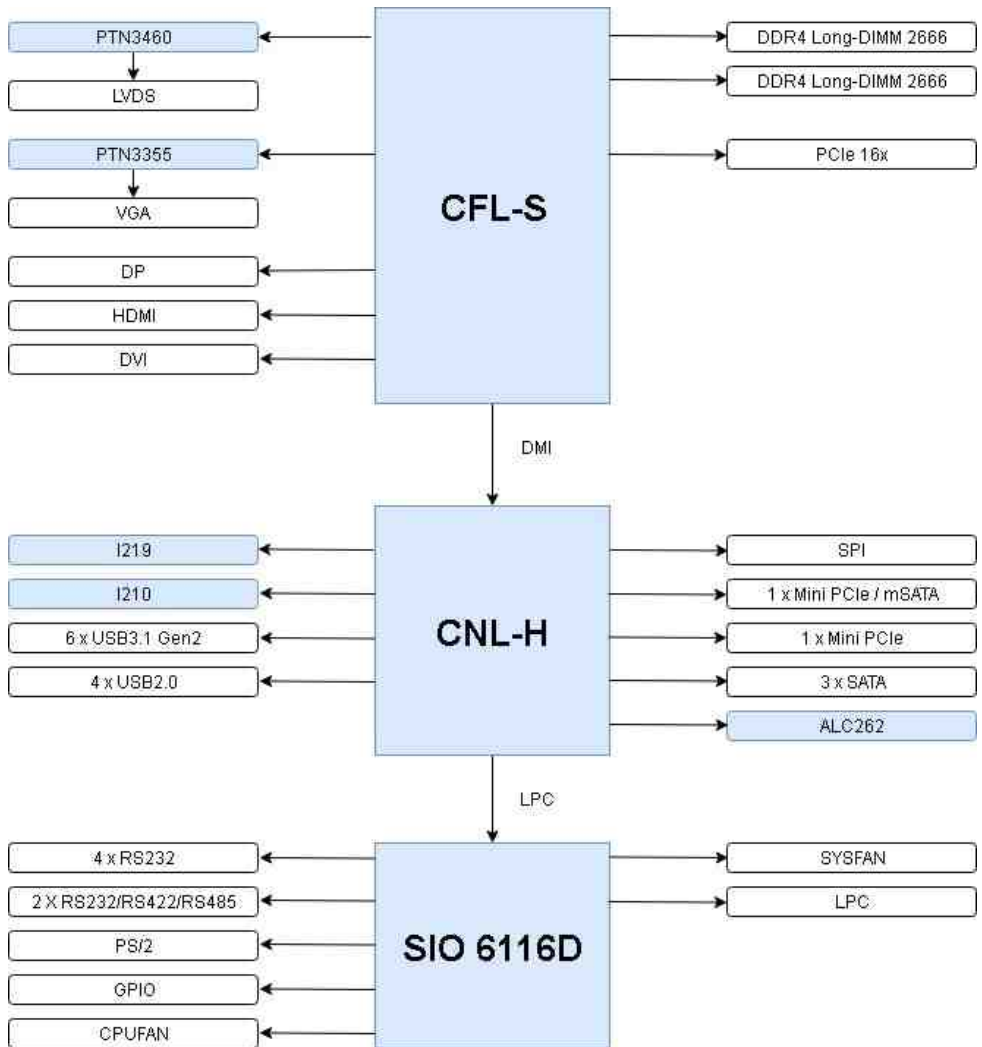

Chapter 2 <Hardware setup>

2.1 <Connector Location and Reference>

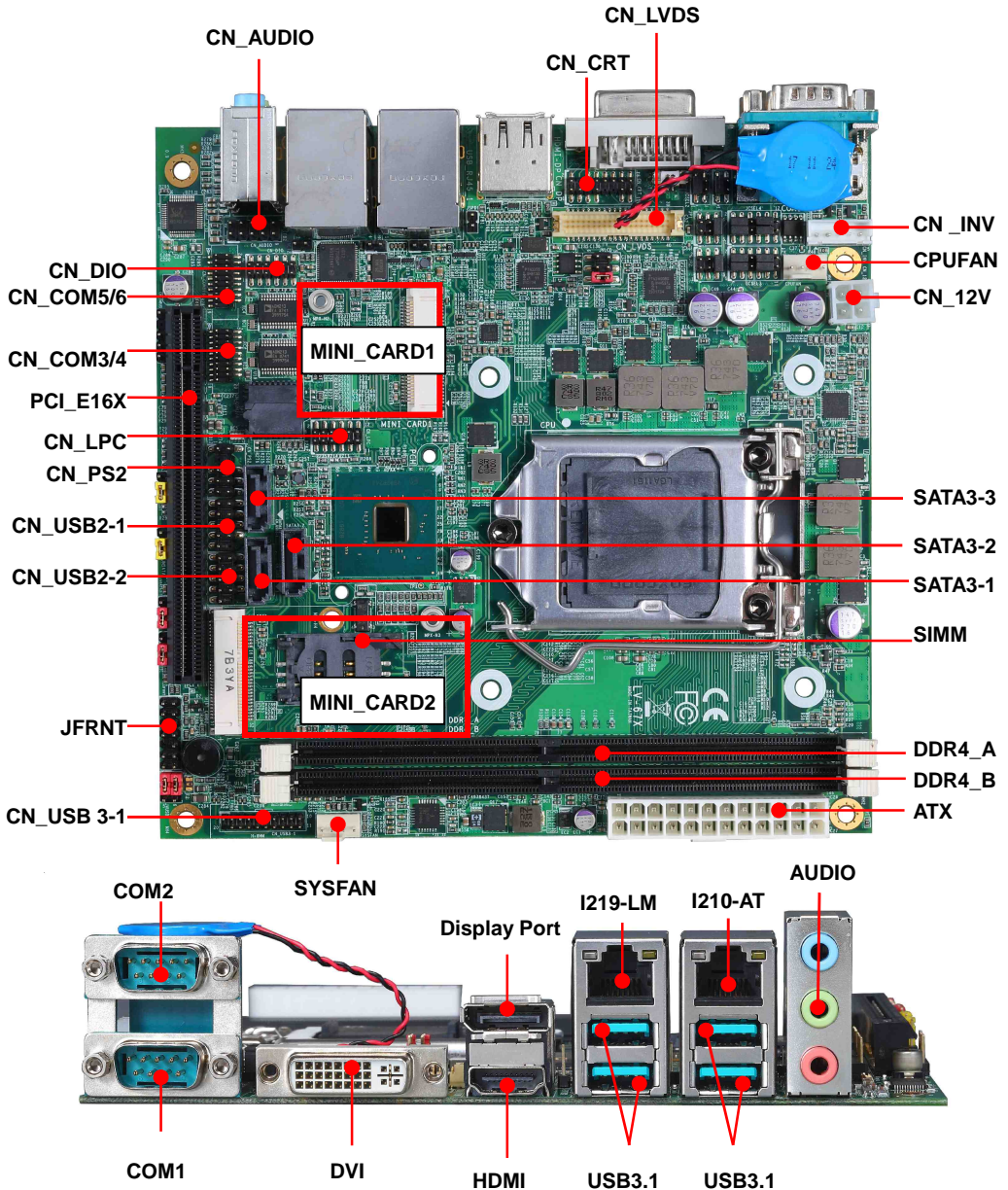

2.1.1 <Internal connectors list>

Connector	Function
DDR4_A/B	288-pin DDR4 DIMM slot
SATA3-1/2/3	7-pin Serial ATA3 connector
CN_AUDIO	5 x 2-pin audio pin header
CN_LPC	6 x 2-pin LPC pin header
CN_LVDS	20 x 2-pin LVDS connector
CN_INV	5-pin LCD inverter connector
CN_SMBUS	5-pin SMBus connector
CN_COM 3/4/5/6	20-pin RS232 connector
CN_USB 2-1/2-2	5 x 2-pin USB2.0 pin header
CN_USB 3-1	10 x 2-pin USB3.1 pin header
CN_PS2	5 x 2-pin PS/2 pin header
CN_DIO	6 x 2-pin digital I/O connector
CN_CRT	16-pin VGA connector
CPUFAN	4-pin CPU fan connector
SYSFAN	4-pin system fan connector
JFRNT	14-pin front panel switch/indicator connector
PCI_E16X	164-pin x16 PCIE slot
MINI_CARD1	52-pin Half-MiniPCle card slot
MINI_CARD2	52-pin MiniPCle card slot
ATX	24-pin power supply connector
CN_12V	4-pin power input Terminal Block
SIMM	6-pin socket

2.1.2 <External connectors list>

Connector	Function
DisplayPort	DisplayPort connector
DVI	DVI connector
HDMI	HDMI connector
USB3.1	USB3.1 Gen2 connector
LAN	RJ45 connector
AUDIO	Audio connector
COM1/2	DB9 Serial port connector

2.2 <CPU and Memory Setup>

2.2.1 <CPU installation>

LV-67X has a LGA1151 CPU socket onboard; please check following steps to install the processor properly.

Attention If LV-67X needs RMA please Keep CPU socket cover on the CPU Socket.

Warning If CPU Socket internal Pin damage We could not provide warranty.



Support 8th & 9th Gen Intel® Core™ Desktop Processors, FCLGA1151 package

1. Lift this bar



2. Uncover this plate

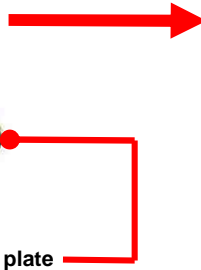

Checked point

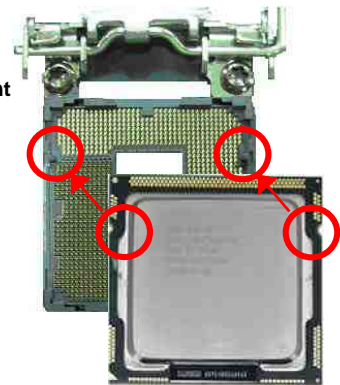

3. Place the CPU on the top of the pins

4. Cover this plate



5. Lock this bar

2.2.2 <Memory Setup>

LV-67X has two 288-pin DDR4 DIMM support up to 64GB of memory capacity and 1.2 Voltage. The memory frequency supports 2666 MHz. Only Non-ECC memory is supported. (Core i3, Pentium, Celeron CPU support 2400 MHz only)



Please check the pin number to match the socket side well before installing memory module.

2.3 <Jumper Location and Reference>

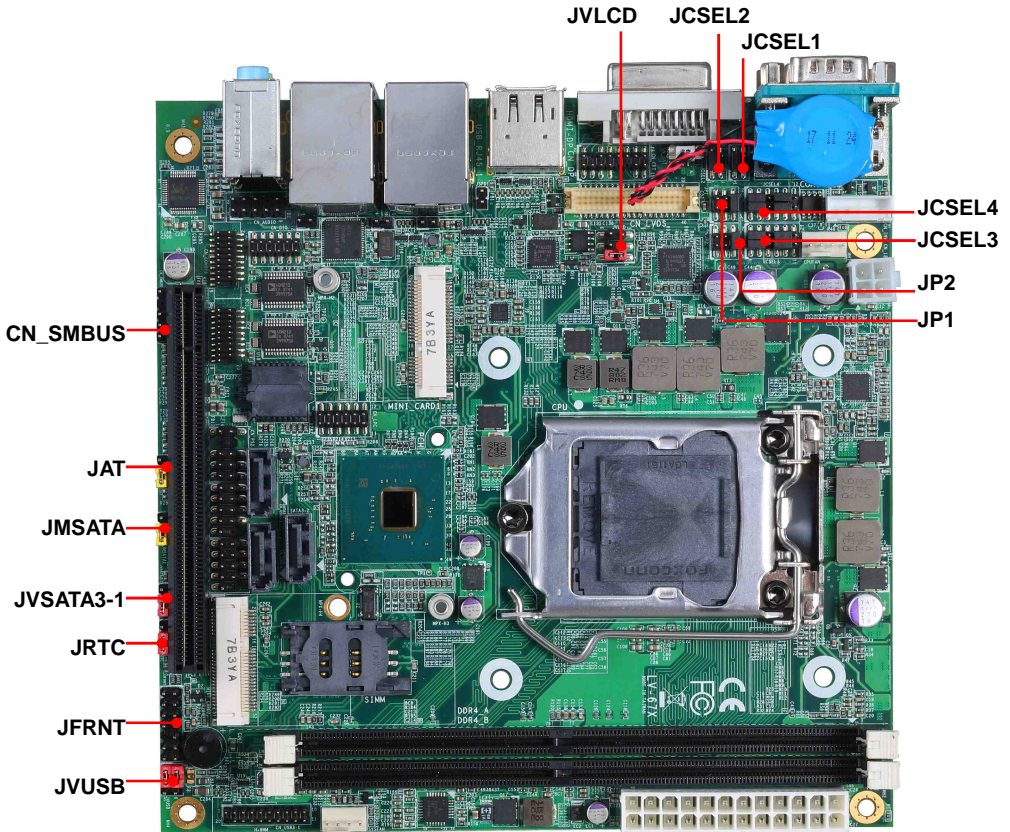

2.3.1 <Jumper list>

Jumper	Function
JAT	Power mode select
JRTC	CMOS Normal/Clear Setting
JVLCD	Panel Voltage Setting
JMSATA	MiniCard 2 MSATA Setting
JP1	COM1 Voltage Setting (For Pin 9)
JP2	COM2 Voltage Setting (For Pin 9)
JCSEL1	COM2 RS-232 RS422 RS485 Setting
JCSEL2	COM1 RS-232 RS422 RS485 Setting
JCSEL3	COM2 RS-232 RS422 RS485 Setting
JCSEL4	COM1 RS-232 RS422 RS485 Setting
JVSATA3-1	Set 5V to SATA3-2 pin 7 (For SATADOM)
JVUSB	USB Voltage Setting

2.3.2 <Clear CMOS and Power on type selection>

The board's data of CMOS can be setting in BIOS. If the board refuses to boot due to inappropriate CMOS settings, here is how to proceed to clear (reset) the CMOS to its default values.

JAT: AT/ATX mode select jumper

Jumper settings	Function
1-2	AT mode
2-3	ATX mode (Default)

JRTC: Clear CMOS data jumper

Jumper settings	Function
1-2	Clear CMOS
2-3	Normal (Default)

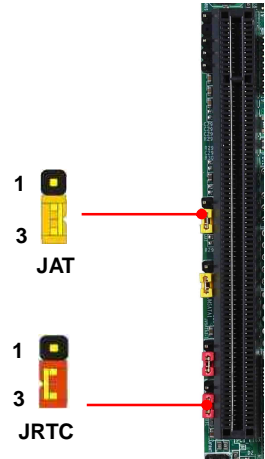

2.4 <I/O interface>

2.4.1 <Serial ATA interface>

SATA 1/2/3: SATA3 7-pin connector

Pin	Signal
1	GND
2	TX+
3	TX-
4	GND
5	RX-
6	RX+
7	GND

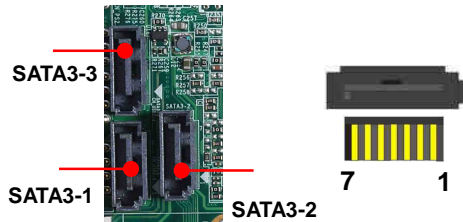

JVSATA3-1: SATA3/SATADOM mode select jumper

Jumper settings	Function
1-2	SATA3-2 SATA DOM (change pin7 to 5V)
2-3	SATA3-2 SATA3 (Default)

If you use SATA DOM, please check your SATA DOM Pin 7. Some device (like Innodisk) require power supply via Pin 7. If not, keep JVSATA3-1 jumper to default setting (2-3).

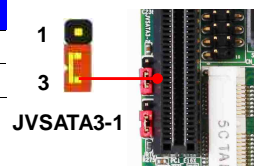

2.4.2 <Ethernet interface>

The board provide I219-LM PHY Gigabit Ethernet and I210-AT Gigabit Ethernet on rear I/O. Intel I219-LM and I210 supports operation at 10/100/1000 Mb/s data rates, with IEEE802.3 compliance and Wake-On-LAN supported.

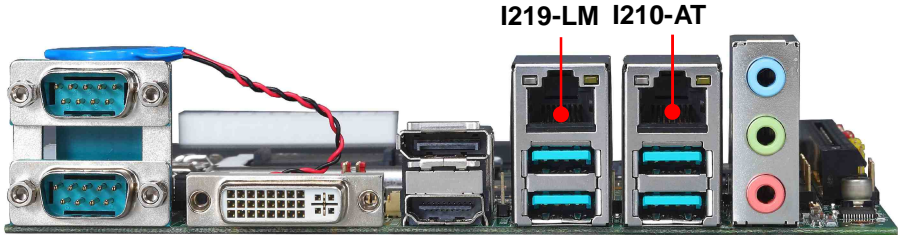

2.4.3 <Display interface>

Based on the 8th Gen CPU with built-in UHD Graphics 630, VGA and DVI up to **1920x1080@60Hz**, DisplayPort up to **4096x2304@60Hz**, HDMI up to **4096x2304@24Hz** on rear IO. About the internal Display, LVDS (PTN3460) up to **1920x1200@60Hz** support 18/24-bit color depth and single/dual channel. About select LCD Panel Type in BIOS, please refer **Appendix B**.

The built-in HD Graphics support triple display function with clone mode and extended mode.

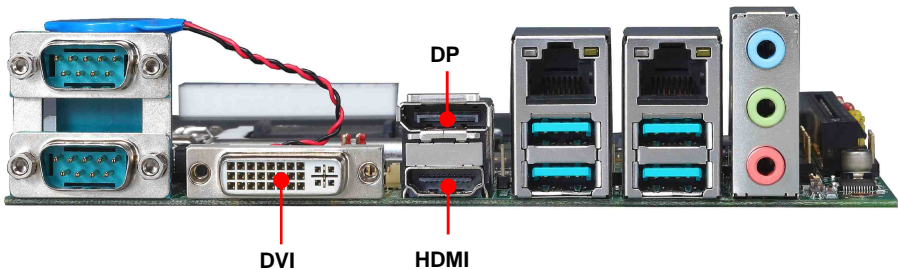

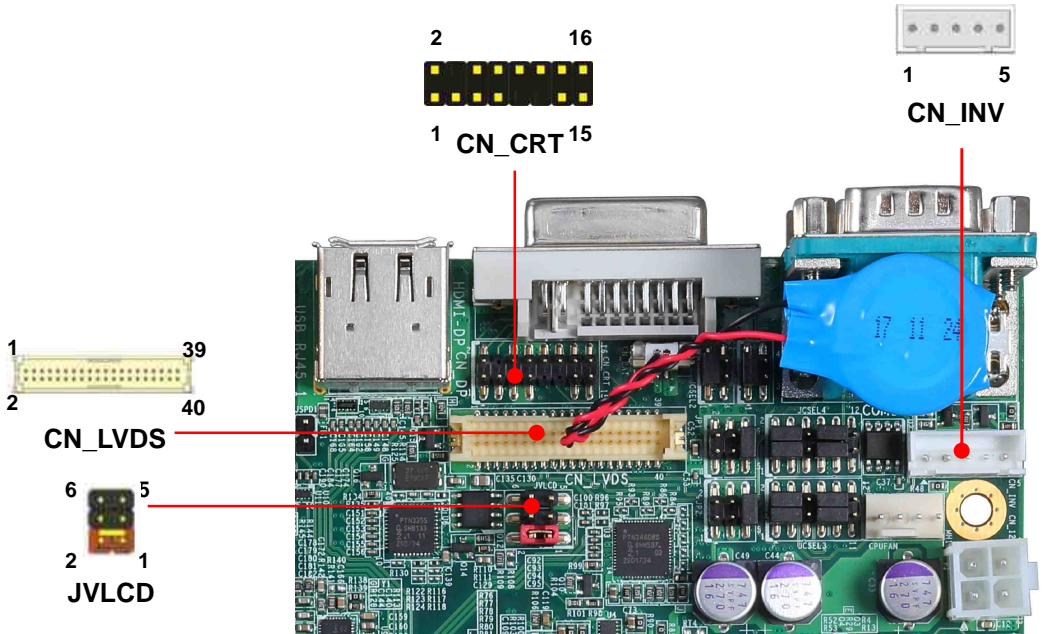
CN_CRT: VGA 16-pin connector (Pitch 2.00 mm)

Pin	Signal	Pin	Signal
1	BR	2	BG
3	BB	4	NC
5	IOGND1	6	IOGND1
7	IOGND1	8	IOGND1
9	NC	10	IOGND1
11	NC	12	5VCD A
13	5HSYNC	14	5VSYNC
15	5VCLK	16	NC

CN_LVDS: LVDS 40-pin connector (Model: HIROSE DF13-40DP-1.25V compatible)

Pin	Signal	Pin	Signal
2	Set by JVLCD	1	Set by JVLCD
4	Detect (Active low)	3	GND
6	A_LVDS_0-	5	B_LVDS_0-
8	A_LVDS_0+	7	B_LVDS_0+

10	GND	9	GND
12	A_LVDS_1-	11	B_LVDS_1-
14	A_LVDS_1+	13	B_LVDS_1+
16	GND	15	GND
18	A_LVDS_2-	17	B_LVDS_2-
20	A_LVDS_2+	19	B_LVDS_2+
22	GND	21	GND
24	A_LVDS_CLK-	23	B_LVDS_3-
26	A_LVDS_CLK+	25	B_LVDS_3+
28	GND	27	GND
30	A_LVDS_3-	29	B_LVDS_CLK-
32	A_LVDS_3+	31	B_LVDS_CLK+
34	GND	33	GND
36	LVDS_DDCSCL	35	NC
38	LVDS_DDCSDA	37	NC
40	NC	39	NC

Pin4 only need to be connected to GND

CN_INV: LVDS 5-pin Backlight power connector

Pin	Signal
1	12V
2	Backlight Control
3	GND
4	GND
5	Enable Backlight

JVLCD: LVDS panel power select jumper

Jumper settings	Function
1-2	3.3V (Default)
3-4	5V
5-6	12V

2.4.4 <Serial Port interface>

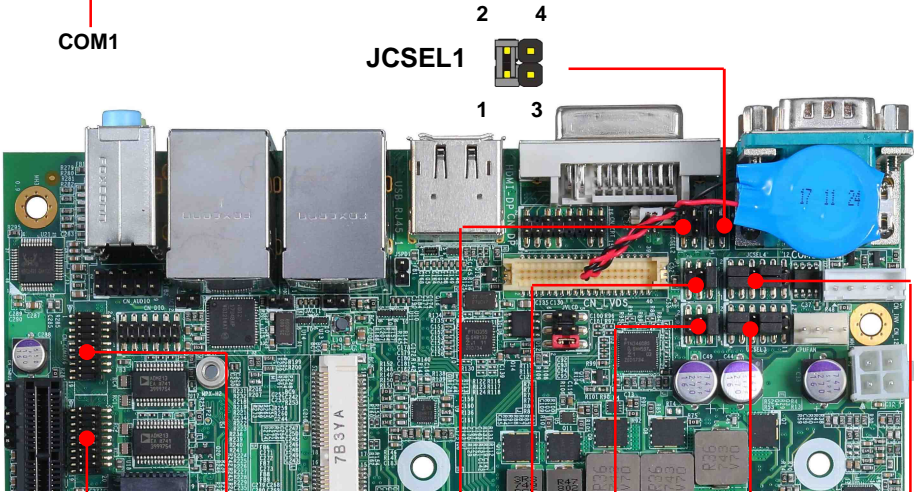
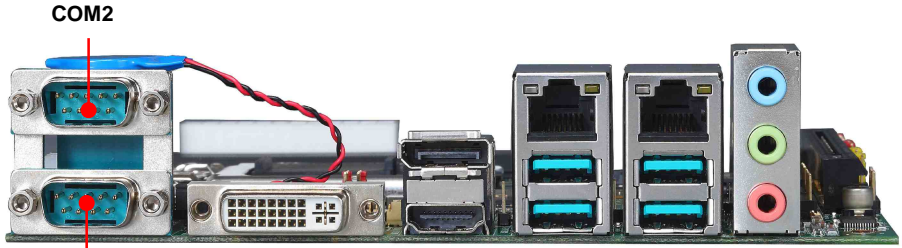

CN_COM5/6 CN_COM3/4

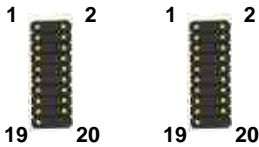

JCSEL2



JP1



JP2



JCSEL3

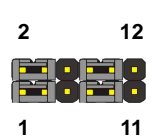

JCSEL4

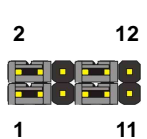

COM1: RS232/422/485 DB9 connector

Pin	Signal	Pin	Signal
1	DCD/ 422TX-/ 485-	2	RXD/ 422TX+/ 485+
3	TXD/ 422RX+	4	DTR/ 422RX-
5	GND	6	DSR
7	RTS	8	CTS
9	Set by JP1		

Note: Use JCSEL2 and JCSEL4 select communication mode

COM2: RS232/422/485 DB9 connector

Pin	Signal	Pin	Signal
1	DCD/ 422TX-/ 485-	2	RXD/ 422TX+/ 485+
3	TXD/ 422RX+	4	DTR/ 422RX-
5	GND	6	DSR
7	RTS	8	CTS
9	Set by JP2		

Note: Use JCSEL1 and JCSEL3 select communication mode

COM3/4: COM 20-pin header (Pitch 2.54 x 1.27mm)

Pin	Signal	Pin	Signal
1	DCD1	2	RXD1
3	TXD1	4	DTR1
5	GND	6	DSR1
7	RTS1	8	CTS1
9	RI1	10	NC
11	DCD2	12	RXD2
13	TXD2	14	DTR2
15	GND	16	DSR2
17	RTS2	18	CTS2
19	RI2	20	Key

COM5/6: COM 20-pin header (Pitch 2.54 x 1.27mm)

Pin	Signal	Pin	Signal
1	DCD1	2	RXD1
3	TXD1	4	DTR1
5	GND	6	DSR1
7	RTS1	8	CTS1
9	RI1	10	NC
11	DCD2	12	RXD2
13	TXD2	14	DTR2
15	GND	16	DSR2
17	RTS2	18	CTS2
19	RI2	20	Key







JP1, JP2: COM1, COM2 pin-9 setting

Jumper settings	Function
1-2	5V
3-4	12V
5-6	RI (Default)

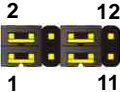
Effective patterns of connection: 1-2 / 3-4 / 5-6

Other may cause damage

JCSEL1 / 3, JCSEL 2/ 4: For configure COM2 & COM1 communication mode

Function	JCSEL3/ JCSEL4	JCSEL1/ JCSEL2
RS232 (Default)		
RS485		
RS422		

RS-485 cable modification:

Com1 RTX- Data- : short Pin1& Pin4

Com1 RTX+ Data+ : short Pin2& Pin3

Com2 RTX- Data- : short Pin1& Pin4

Com2 RTX+ Data+ : short Pin2& Pin3

2.4.5 <USB interface>

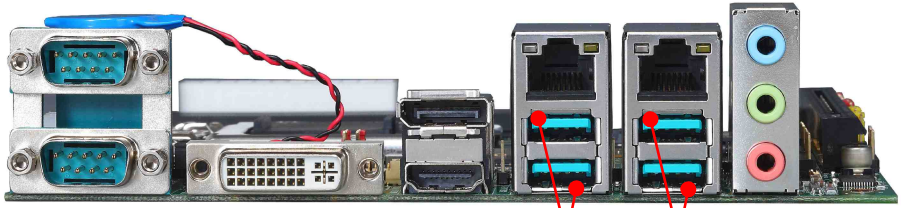

USB3.1
(LEFT)

USB3.1
(RIGHT)

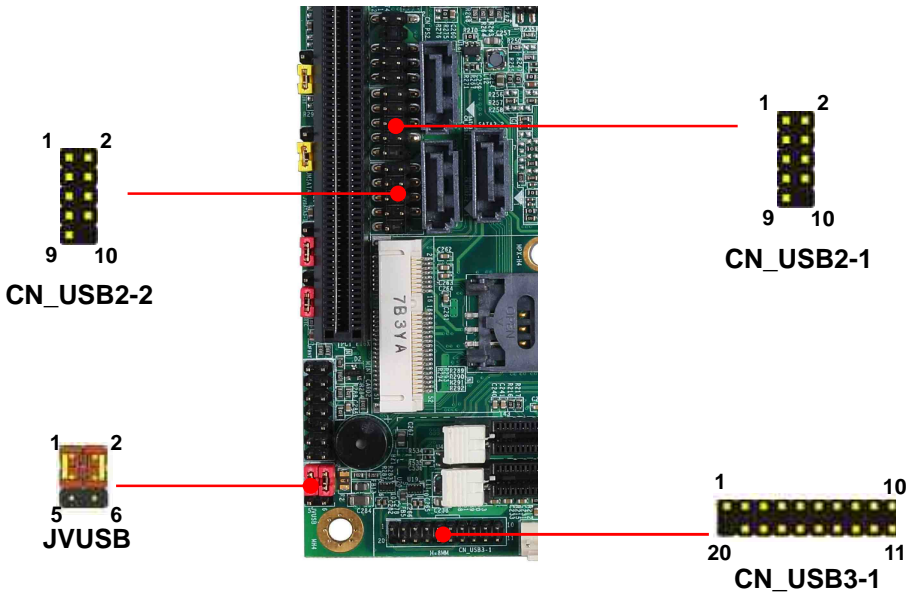

CN_USB 2-1/2-2: USB2.0 10-pin header (Pitch 2.54 mm)

Pin	Signal	Pin	Signal
1	5VSB	2	5VSB
3	DATA0-	4	DATA1-
5	DATA0+	6	DATA1+
7	GND	8	GND
9	GND	10	Key

CN_USB3-1: USB3.1 20-pin header (Pitch 2.00 mm)

Pin	Description	Pin	Description
1	VCC (5V_SB/ 5V)	20	NC
2	USB3.1_RX0-	19	VCC (5V_SB/ 5V)
3	USB3.1_RX0+	18	USB3.1_RX1-
4	Ground	17	USB3.1_RX1+
5	USB3.1_TX0-	16	Ground
6	USB3.1_TX0+	15	USB3.1_TX1-
7	Ground	14	USB3.1_TX1+
8	Data0-	13	Ground
9	Data0+	12	Data1-
10	NC	11	Data1+

JVUSB: 6-pin Power select jumper

Pin	Description
1-3 & 2-4	5V_SB (Default)
3-5 & 4-6	5V

- 1.Effective patterns of connection: 1-3 & 2-4 or 3-5 & 4-6
- 2.JVUSB can control CN_USB3-1 and USB3.1(LEFT) power
- 3.USB3.1(RIGHT) have 5V_SB

2.4.6 <Audio interface>

Rear Audio Jack



- Line in
- Line out
- Mic in

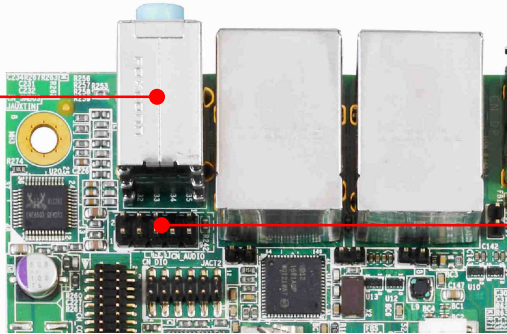

CN_AUDIO: Front panel audio 10-pin header (Pitch 2.54mm)

Pin	Signal	Pin	Signal
1	MIC_L	2	GND
3	MIC_R	4	NC
5	FP_OUT_R	6	MIC_DETECT
7	SENSE	8	Key
9	FP_OUT_L	10	FP_OUT_DETECT

2.4.7 <Expansion slot>

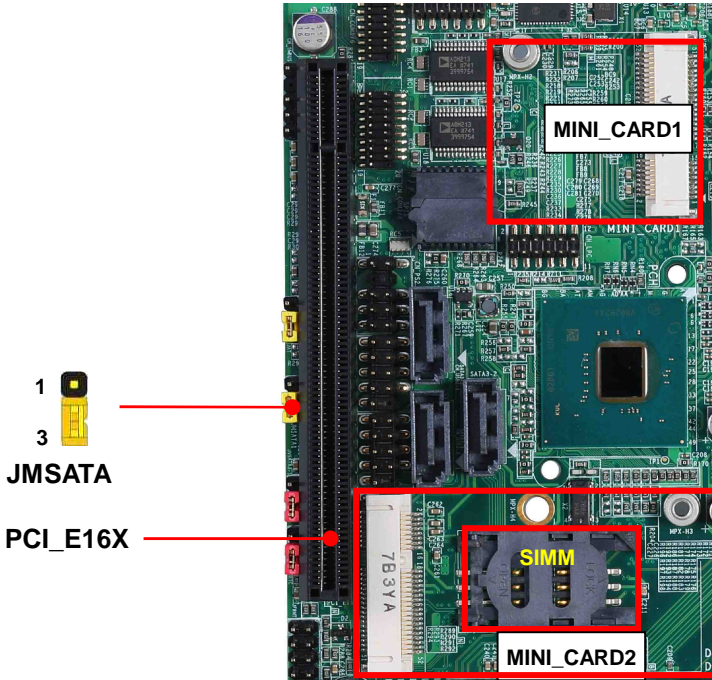

MINI_CARD1 and MINI_CARD2 have some special design to compatible our mini-PCIe card. (ex: MPX-574D2, MPX-210D2 etc)

MINI_CARD2 support mSATA by JMSATA, and connect SIM card with 3G module.

JMSATA: Setting MINI_CARD2 to support PCIe/mSATA

Jumper settings	Function
1-2	Support mSATA
2-3	Normal operation (Default)

2.4.8 <Front panel switch and indicator>

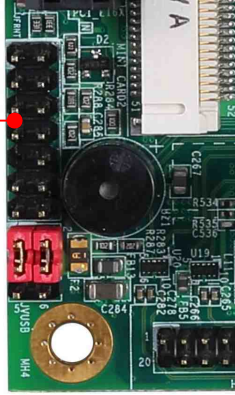
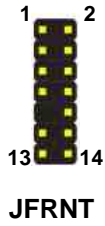

JFRNT: Front panel switch and indicator 14-pin header (Pitch 2.54mm)

Pin	Signal	Pin	Signal
1	HDD_LED+	2	Power_LED+
3	HDD_LED-	4	NC
5	Reset+	6	Power_LED-
7	Reset-	8	Speaker+
9	Key	10	NC
11	Power_ON+	12	NC
13	Power_ON-	14	Speaker-

2.4.9 <GPIO and Other interface>

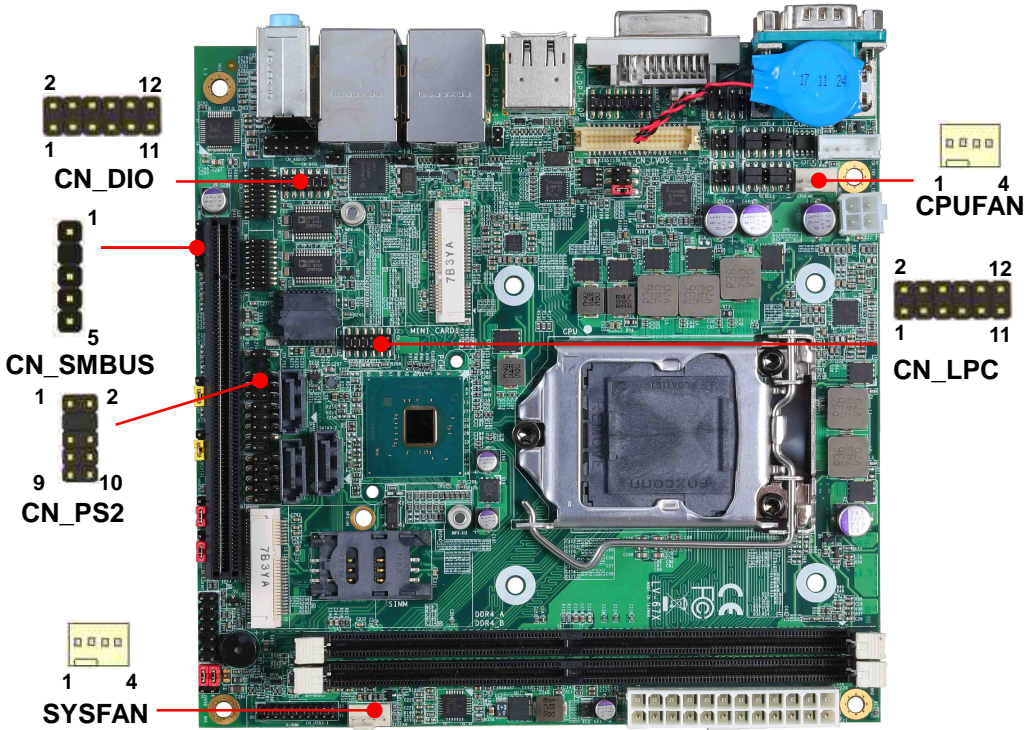

When using GPIO function

Press Delete to enter BIOS Setup menu

On **Front Page** screen, click Setup Utility

On **Advanced** screen, click SIO NCT6116D, then click GPIO 4 Configuration



Internal Resistance: Select output type, Push pull or Open drain

Input/Output mode: Select GPIO pin mode, Input or Output

Pei Phase output value: GPIO output value in BIOS pei phase

Dxe Phase output value: GPIO output value in BIOS dxe phase

As Input: **TTL-level**.

GPIO DC characteristics

Parameter	SYM	MIN	TYP	MAX	UNIT	Conditions
Input Low Voltage	V_{IL}			0.8	V	
Input High Voltage	V_{IH}	2.0			V	
Output Low Voltage	V_{OL}			0.4	V	$I_{OL} = 12\text{mA}$
Input High Leakage	I_{LIH}			+10	μA	$V_{IN} = 3.3\text{V}$
Input Low Leakage	I_{LIL}			-10	μA	$V_{IN} = 0\text{V}$

Please refer to **Appendix E** to program the configuration register

CN_DIO: GPIO 12-pin header (Pitch 2.00mm)

Pin	Signal	Pin	Signal
1	GND	2	GND
3	GP40	4	GP44
5	GP41	6	GP45
7	GP42	8	GP46
9	GP43	10	GP47
11	5V	12	12V

CN_LPC: LPC 12-pin header (Pitch 2.00mm)

Pin	Signal	Pin	Signal
1	CLK	2	RST
3	-LFRAME	4	LAD3
5	LAD2	6	LAD1
7	LAD0	8	3.3V
9	SERIRQ	10	GND
11	3.3VSB	12	NC

CN_PS2: PS/2 10-pin header (Pitch 2.54mm)

Pin	Signal	Pin	Signal
1	KB_DATA	2	M_DATA
3	NC	4	NC
5	GND	6	GND
7	VCC	8	VCC
9	KB_CLK	10	M_CLK

CN_SMBUS: SMBus 5-pin connector (Pitch 2.54mm)

Pin	1	2	3	4	5
Signal	5V	NC	SMBDAT	SMBCLK	GND

CPUFAN: CPU cooler fan 4-pin connector

Pin	1	2	3	4
Signal	GND	12V	Sensor	Control

SYSFAN: System cooler fan 4-pin connector

Pin	1	2	3	4
Signal	GND	12V	Sensor	Control

2.5 <Power supply>

2.5.1 <Power input>

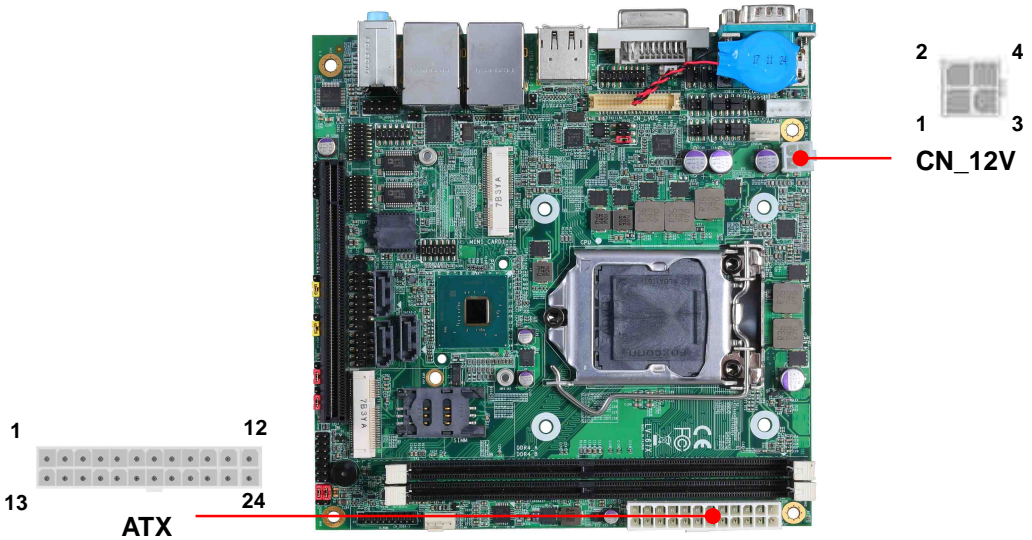

CN_12V: ATX12V 4-pin connector

Pin	Signal	Pin	Signal
1	GND	2	GND
3	12V	4	12V

ATX: main power 24-pin connector (As input)

Pin	Signal	Pin	Signal
1	3.3V	13	3.3V
2	3.3V	14	NC
3	GND	15	GND
4	5V	16	-PSON
5	GND	17	GND
6	5V	18	GND
7	GND	19	GND
8	Power_OK	20	NC
9	5VSB	21	5V
10	12V	22	5V
11	12V	23	5V
12	3.3V	24	GND

Appendix A <Flash BIOS>

A.1 <Flash tool>

The board is based on Insyde BIOS and can be updated easily by the BIOS auto flash tool. You can download the tool online at the address below:

[FPT Tool](#)

The tool's file name is "FPT.exe", it's the utility that can write the data into the BIOS flash chip and update the BIOS.

A.2 <Flash BIOS process>

1. Press Del to Enter BIOS Menu
2. On Front Page screen, click Setup Utility
3. On Advenced screen, click PCH-IO Configuration, then click Security Configuration
4. Set BIOS Lock to [Disabled], then save changes.



5. Please make a boot-able Disk which could booting into DOS environment.
6. Un-zip attached files and copy it into boot-able Disk.
7. Power on the system and flash the BIOS under the DOS environment.

The instruction will be "C:/fpt_-savemac_-f_XXXX.BIN"

Note: a. Underscore means Space

b. xxxx.bin means the BIOS file that you want to update

8. Please turn off the system and clean CMOS by Jumper.
9. Turn on the system and update BIOS successful.

Appendix B <LCD Panel Type select>

According to your panel, it needs to select the correct resolution in the BIOS. If there is no fit for your panel type, please provide feedback for us to make an OEM model.

Find the setting from

Front Page-> Setup Utility

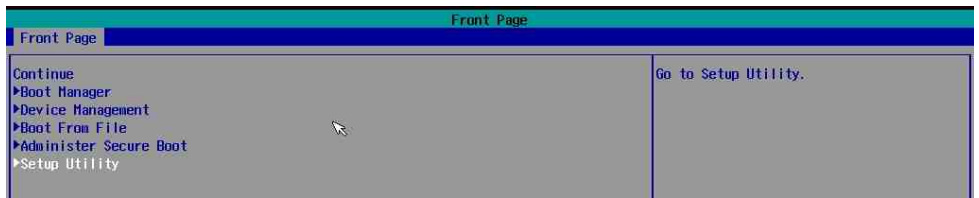

Advanced > LVDS Configuration



Set 18bit /24bit, Single /Dual channel in LVDS configuration

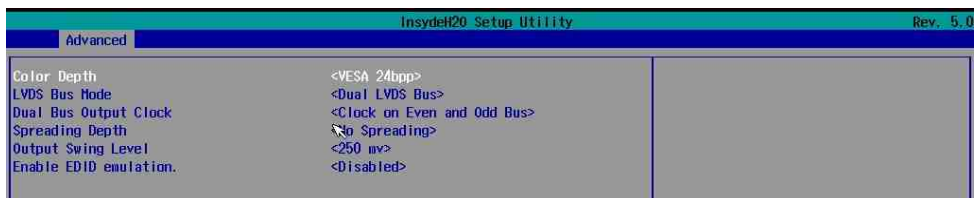

Advanced Ú SA configuration Ú Graphics configuration Ú

LCD control Ú LCD Panel Type

There are 16 resolutions in LCD Panel Type. (For Dual boot and Legacy boot)

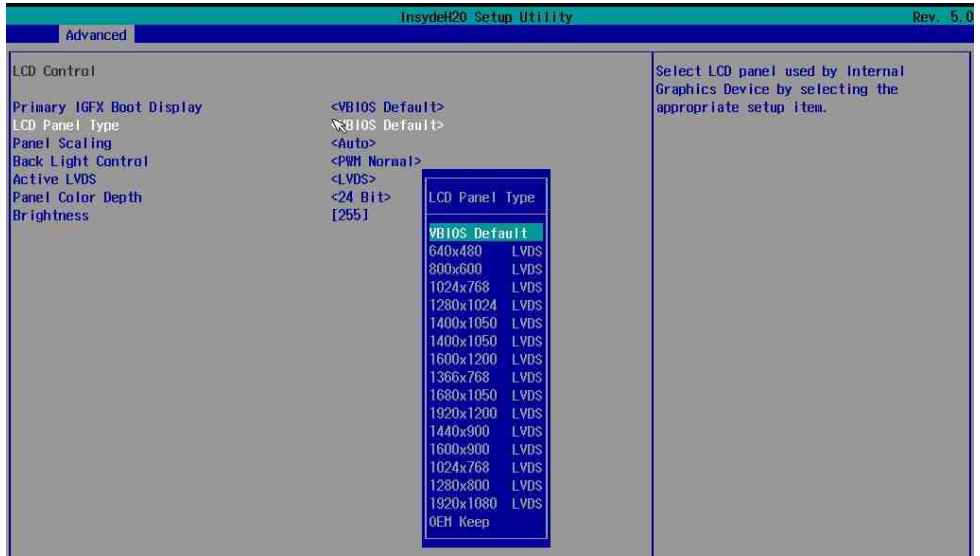

Appendix C <Programmable Watch Dog Timer>

The watchdog timer makes the system auto-reset while it stops to work for a period. The integrated watchdog timer can be setup as system reset mode by program. You can select Timer setting in the BIOS, after setting the time options, the system will reset according to the period of your selection.

Find the setting from

Advanced → SIO NCT6116D

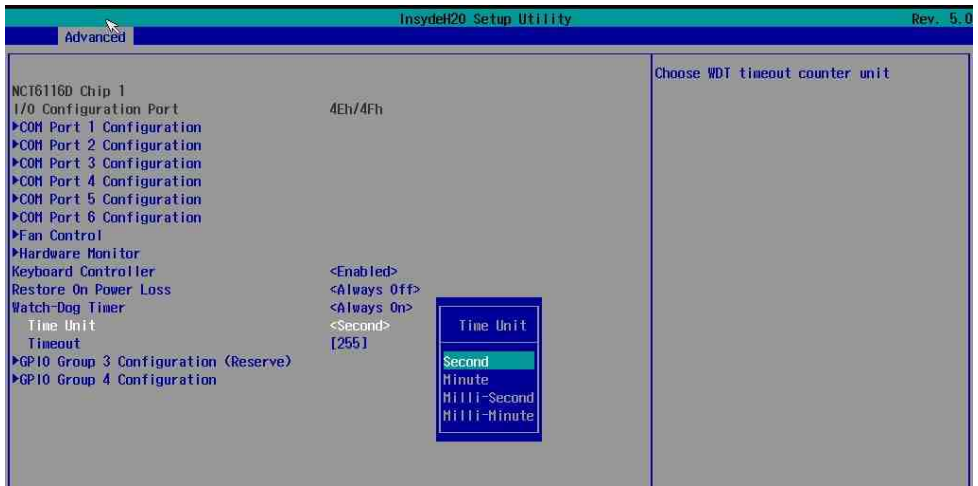

Timeout value range

1 to 255 Minute and Second

Program sample

Watchdog timer setup as system reset with 5 second of timeout

```
-o 4E 87      ;enter configuration
-o 4E 87
-o 4E 07
-o 4F 08      ;select Logical Device
-o 4E 30
-o 4F 01      ; activate WDTO# function
-o 4E F0
-o 4F 00      ;set "00" is second mode, set "08" is minute mode
-o 4E F1
-o 4F 05      ;00h: Timeout Disable
                ;01h: Timeout occurs after 1 minute only
                ;02h: Timeout occurs after 2 second/minute
                ;03h: Timeout occurs after 3 second/minute
                ;
                ;FFh: Timeout occurs after 255 second/minute
                (The deviation is approx 1 second.)
```

For further information, please refer to Nuvoton NCT6116D datasheet

Appendix D <Hardware Monitor>

Find the setting from

Advanced → SIO NCT6116D → Hardware Monitor

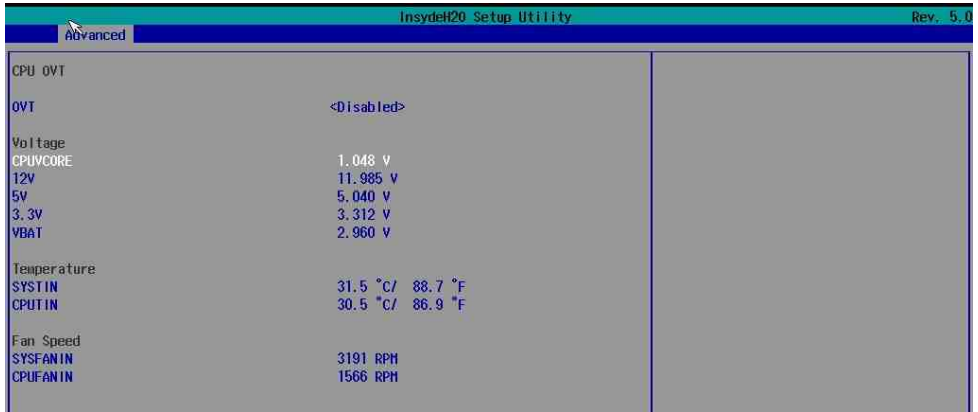

The screenshot shows the 'Advanced' tab of the 'InsydeH2O Setup Utility' (Rev. 5.0). The 'Hardware Monitor' section displays the following data:

Category	Item	Value
CPU OVT	OVT	<Disabled>
Voltage	CPUVCORE	1.048 V
	12V	11.985 V
	5V	5.040 V
	3.3V	3.312 V
	VBAT	2.960 V
Temperature	SYSTEM	31.5 °C / 88.7 °F
	CPUFAN	30.5 °C / 86.9 °F
Fan Speed	SYSTEM	3191 RPM
	CPUFAN	1566 RPM

Appendix E <Programmable GPIO>

The GPIO' can be programmed with the MS-DOS debug program using simple IN/OUT commands.

GPIO	0	1	2	3	4	5	6	7
bit	0	1	2	3	4	5	6	7

- o 4E 87 ;enter configuration
- o 4E 87
- o 4E 07
- o 4F 07 ;select Logical Device
- o 4E 30
- o 4F 10 ;activate GPIO function (The board use GPIO4)
- o 4E F0
- o 4F XX ;set "01" GPIO as input, set "00" GPIO as output
- o 4E F1
- o 4F XX ;if set GPIO as output, this register's value can be set "00~ FF"

Optional

- o 4E F2
- o 4F XX ;set "01", the respective bit are inverted (Both input and output)
- ;set "00", the respective bit are normal

For further information, please refer to Nuvoton NCT6116D datasheet

Appendix F <RAID Setting>

When use RAID function, it need to enter the BIOS set RAID mode first.

Advanced ú PCH-IO Configuration ú SATA and RST Configuration

ú SATA Mode Selection

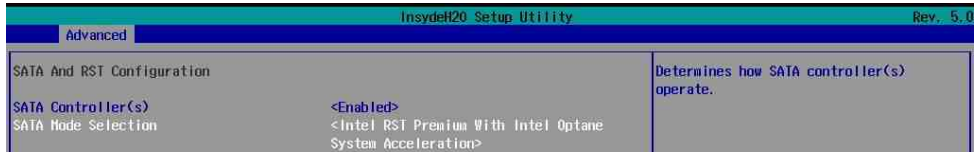

Advanced ú PCH-IO Configuration ú SATA and RST Configuration

ú Software Feature Mask Configuration

Set Use RST Legacy OROM ú [Enable]



Then press F10 to save the setting.

At boot time, press <CTRL + I> to enter the RAID configuration menu.



Appendix G <Setup ADP-3355,ADP-3460>

LV-67XT have a 2nd VGA or 2nd LVDS, it's no need install extra driver.

For further information, please refer to the manual.

ADP-3355 manual [Link](#)

ADP-3460 manual [Link](#)

Contact information

Any advice or comment about our products and service, or anything we can help you please don't hesitate to contact with us. We will do our best to support you for your products, projects and business.

Taiwan Commate computer Inc.

Address	19F., NO.94, Sec. 1, Xintai 5 th Rd., Xizhi Dist., New Taipei City 22102, Taiwan.
TEL	+886-2-26963909
Website	www.commell.com.tw
E-mail	info@commell.com.tw (General information) tech@commell.com.tw (Technical Support)

Commell is a brand name of Taiwan Commate computer Inc.